

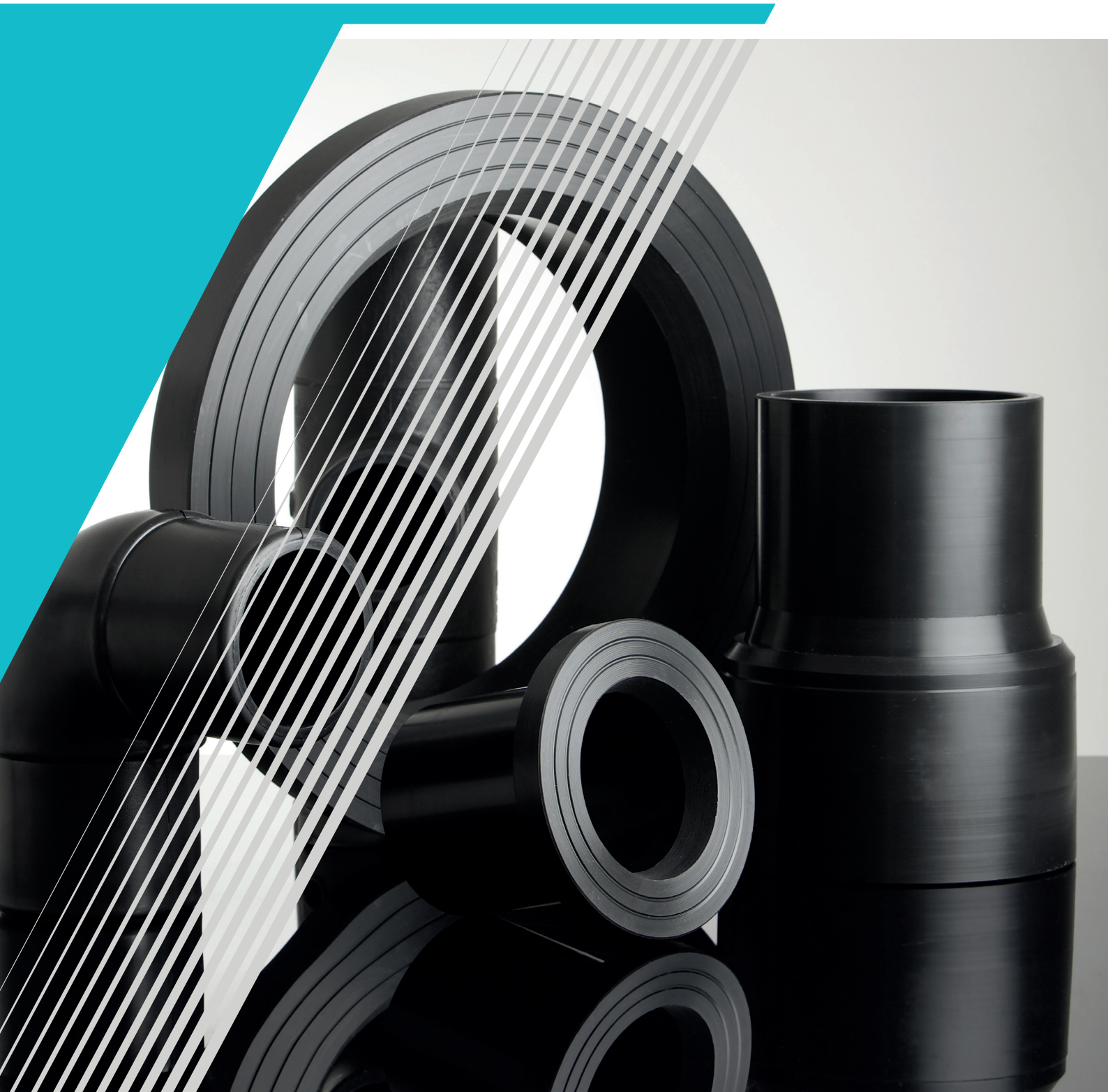

ABRAM
E T T E S A L

ABAN BASPAR PARSIAN

Technical Catalog(2023)





ABRAM
E T T E S A L

شرکت آبان بسپار پارسیان با سال‌ها تجربه در زمینه تامین لوله و اتصالات پلیمری از سال ۱۳۹۰ با توجه به پیشینه و تجربیات کاری در راستای تحقق سیاست‌های کلان بهبود و بهره‌وری در صنایع آب و فاضلاب، نفت، معدنی و نیروگاهی با برند آبرام اتصال، پای در عرصه‌ی تولید اتصالات پلی‌اتیلن جوشی و پی‌وی‌سی نهاده است.

← واحد کنترل کیفیت

واحد کنترل کیفیت شرکت آبان بسپار پارسیان به منظور تامین برنامه‌ریزی بلندمدت، سیاست جذب، همکاری و جلب رضایت مشتریان و همچنین اطمینان از کیفیت اتصالات تولیدی در این مجموعه تشکیل شده است.

کلیه مراحل شامل ورود مواد اولیه، فرایند تولید، محصول نهایی، انبارداری و بارگیری تحت نظر این واحد انجام می‌گیرد. همچنین آزمون‌های مربوط به مواد اولیه پلی‌اتیلن و اتصالات تولیدی در آزمایشگاه این شرکت مطابق با استاندارد ملی ۱۴۴۴۲۷ و ۱۶۹۶۳ و DIN8074 انجام می‌پذیرد. کلیه اتصالات تولیدی این شرکت علاوه بر دارا بودن علامت استاندارد ملی ایران، دارای تاییدیه‌ی معاونت فنی مجری طرح سامانه‌های نوین آبیاری معاونت آب‌و خاک وزارت جهادکشاورزی می‌باشد.

← واحد تحقیق و توسعه

واحد مذکور از بدو تاسیس شرکت آبان بسپار پارسیان به منظور تحقق موارد زیر تشکیل شده است:
 . پیشرفت در صنعت لوله‌و اتصالات
 . افزایش سطح کیفی محصولات و تولید محصولات جدید
 . برنامه‌ریزی و هدف‌گذاری‌های نوین

← آشنایی با محصولات

تولید اتصالات تزریقی تا سایز ۳۱۵ میلیمتر
 تولید انشعابات برنجی
 چهارراه جوشی پلی‌اتیلن
 درپوش جوشی پلی‌اتیلن
 تولید انواع کلکتور و اتصالات خاص و سفارشی

فلنج پلی‌اتیلن تا سایز ۱۲۰۰ میلیمتر
 تبدیل هم‌مرکز پلی‌اتیلن تا سایز ۱۲۰۰ میلیمتر
 تبدیل غیر هم‌مرکز پلی‌اتیلن تا سایز ۱۲۰۰ میلیمتر
 زانوی جوشی پلی‌اتیلن در زوایای مختلف
 انواع سهراهی جوشی پلی‌اتیلن

← مزایای استفاده از لوله و اتصالات پلی‌اتیلن

بارگیری، حمل‌ونقل و باراندازی آسان‌تر
 مقاومت بالا در مقابل ارتعاشات ناشی از زمین‌لرزه
 قابلیت استفاده در زمین‌های ناهموار، خاک‌های خورنده و شیمیایی
 نصب و اجرای آسان
 مقاومت بالا در مقابل نور خورشید و اشعه ماورابنفش

تنوع کاربری در زمینه‌های مختلف
 عمر طولانی‌مدت
 وزن پایین‌تر نسبت به انواع اتصالات
 مقاومت بالا در مقابل شکستگی و ترک‌خوردگی
 مقاومت بالا در مقابل اکسید، سایش، و خوردگی



Aban Baspar Parsian Company has started its activities in manufacturing the welded polyethylene fittings since 2011 under the brand of Abram Ettesal based on its professional record and many years of experiences in supplying the polymer pipes and fittings in order to accomplish the great improvement and efficiency policies in water, wastewater, oil, mineral and power plant industries.

► Quality Control Unit

The Quality Control Unit of Aban Baspar Parsian Company has been established for long-term programming, absorption policy, cooperation, satisfaction of customers and assurance of the quality of its manufactured fittings.

All phases including entrance of raw materials, production process, final product, storage and loading are under the supervision of this unit.

Meanwhile, the related tests of polyethylene raw materials and manufactured fittings are performed in the laboratory of this company based on national standards 14427, ISO 4427 and DIN 8074.

All the manufactured fittings of this company not only have the Iran standard mark but also the confirmation of technical deputy and executor of the new irrigation systems plan of the Water and Soil Deputy of Agriculture Ministry.

► Research and Development Unit

The said unit has been established concurrently with the establishment of Aban Baspar Parsian Company in order to achieve the following items:

- Development in pipe and fittings industry
- Promotion the quality level of the products and production of new products
- New programming and targeting

► Introduction to Products

- | | |
|--|--|
| <ul style="list-style-type: none"> ▪ Polyethylene Spigot Fittings ▪ Polyethylene Fabricated Fittings ▪ Backing Ring | <ul style="list-style-type: none"> ▪ Polyethylene Valves ▪ Special Fittings such as collectors |
|--|--|

► Advantages of Polyethylene Pipes and Fittings Utilization

- | | |
|--|---|
| <ul style="list-style-type: none"> ▪ Usage variety in different fields ▪ Long-term lifetime ▪ Lighter weight than other fittings ▪ High resistance against fracture and cracking ▪ High resistance against oxides, erosion and corrosion ▪ High resistance against sunlight and UV ▪ Easy installation and implementation | <ul style="list-style-type: none"> ▪ Easy loading and storage ▪ High resistance against the earthquake vibrations ▪ Usability in uneven lands and chemical and corrosive soils |
|--|---|

شركة "آبان بسبار بارسيان" هي ذات العديد من سنوات الخبرة في مجال توفير أنابيب البوليمر و التوصيلات والتي لقد حانت منذ عام ١٣٩٠ هـ. ش بعلامة "أبرام اتصال" حيز إنتاج توصيلات البولي إيثيلين الملحومة و بالنظر إلى الخلفية و تجربة العمل حتى حققت السياسات العامة للتحسين و الإنتاجية في صناعات المياه و الصرف الصحية و النفط والمناجم و محطات الطاقة.

← وحدة مراقبة الجودة

تم تشكيل وحدة مراقبة الجودة لشركة آبان بسبار بارسيان من أجل توفير التخطيط طويل الأمد و طرق جذب العملاء و مشاركتهم و رضائهم و أيضا التأكد من جودة الملحقات المنتوجة في هذه المجموعة.

يتم اجراء جميع الخطوات تحت إشراف هذه الوحدة والذي يشمل المواد الخام و عملية الإنتاج و المنتج النهائي و التخزين والشحن.

جدير بالذكر أيضا يتم إجراء الإختبارات ذات الصلة بالمواد الخام للبولي إيثيلين و الملحقات المنتوجة في مختبر هذه الشركة وفقا لمعايير **14427** و **ISO4427** و **DIN8074** الوطنية.

إضافة على إمتلاك علامة إيران القياسية لجميع ملحقات هذه الشركة لقد تمت أيضا الموافقة عليه من قبل مساعد الفني التنفيذي لخطة أنظمة الري الجديدة لوكيل شؤون المياه و التربة في وزارة الزراعة.

← وحدة البحث والتوير

هذه الوحدة منذ تأسيس شركة آبان بسبار بارسيان تم تشكيلها من أجل تحقيق ما يلي:

- التقدم في صناعة الأنابيب والملحقات
- زيادة جودة المنتجات و إنتاج المنتجات الجديدة
- التخطيط و الإستهداف الجديد

← مقدمة في المنتجات

- تركيبات حنفيه البولي إيثيلين
- تركيبات ملفقة من البولي إيثيلين
- حلقة الدعم
- صمامات البولي إيثيلين
- إنتاج أنواع الجامع والتوصيلات المخصصة

← فوائد استخدام أنابيب البولي ايثيلين و ملحقاتها

- التطبيق المتنوع في المجالات المختلفة
- المتانة طويلة الأجل
- الوزن الأقل من انواع التوصيلات
- المقاومة العالية ازاء الكسر و الشقاق
- المقاومة العالية ازاء الأكسيد و التآكل
- المقاومة العاليه ازاء أشعة الشمس والأشعة فوق البنفسجية
- التركيب و التطبيق السهل
- الشحن و النقل و والإرساء السهل
- المقاومة العالية ازاء الإهتزازات الناجمة عن الزلازل
- قابليتها للإستخدام في التضاريس الوعرة و التربة المسببة للتآكل و التربة الكيماوي

Компания «Абан Баспар Парсиан» с многолетним опытом в области обеспечения и производства полиэтиленовых труб и фитингов с 2011 года с учетом своей историей своей работы и опыта в целях реализации стратегии компании, а также оптимизации и повышения производительности в отраслях водоснабжении и канализации, нефти, горной промышленности и энергетических проектов начала производства сварных полиэтиленовых фитингов с товарным знаком «АБРАМ ЭТТЕСАЛ» (ABRAM ETTESAL).

➤ Отдел контроля качества

Отдел контроля качества компании «Абан Баспар Парсиан» был создан в данном комплексе в целях обеспечения долгосрочного планирования, привлечения клиентов, сотрудничества и удовлетворения клиентов, а также надежности и гарантии качества полимерных соединений и фитингов.

Все этапы, включая поступление исходных материалов, процессы производства, окончательная продукция, складирование и погрузка осуществляются под наблюдением данного отдела.

Также испытания полиэтиленовых исходных материалов и производимых фитингов осуществляются в лаборатории данной компании в соответствии с национальными стандартами № 14427, ISO4427 и 8074.

Все производимые в данной компании фитинги имеют сертификат соответствия национальным стандартом Ирана, удостоверения технического департамента исполнителя новых оросительных систем, департамента воды и почвы при министерстве сельского хозяйства.

➤ Отдел исследования и развития

Указанный отдел с момента учреждения компании «Абан Баспар Парсиан» был создан в целях реализации нижеуказанных вопросов:

- Прогресс в промышленности по производству труб и фитингов;
- Увеличение уровня качества продукции и производство новых видов продукции;
- Планирование и определение новых целей.

➤ Ознакомление с продуктами

- Фитинги с хвостовиком
- Сеченные Фитинги
- Опорное кольцо
- Полиэтиленовый Клапаны
- Производство различных видов коллекторов, специальных и заказных фитингов;
- Привилегия и преимущества использования полиэтиленовыми трубами и

➤ Привилегия и преимущества использования полиэтиленовыми трубами и фитингами

- Разнообразие в различных областях;
- Долгий срок службы;
- Небольшой вес по сравнению с другими соединениями и фитингами;
- Высокая прочность до перелома и трещины;
- Высокая прочность до окисления, эрозии и коррозии;
- Высокая прочность под солнечными лучами и ультрафиолетовыми лучами;
- Легкий монтаж и выполнение;
- Удобная погрузка, удобный транспорт и удобная выгрузка;
- Высокая стойкость к вибрации от землетрясения;
- Можно использовать их в неравных земельных участках, агрессивных почвах и химических средах.





آزمایشگاه

Laboratory

Geometrical characteristics

Dimension

ISO 4427
 INSO 14427

Physical characteristics

Density

ISO 1183-1
 INSO 7090-1

Carbon Black Content

ISO 6964
 INSO 19990

Tensile Strength

ISO 6259-1,3
 INSO 17140-1,3

MFI

ISO 1133-1
 INSO 6980-1

Carbon Black Dispersion

ISO 18553
 INSO 20059

Tensile for butt fusion

ISO 13953
 INSO 17304

OIT

ISO 11357-6
 INSO 7186-6

Volatile Content

BS EN 12099
 INSO 19441

Longitudinal Reversion

ISO 2505
 INSO 17614

Mechanical characteristics

Hydrostatic

ISO 1167-1,2
 ISIRI 12181-1,2



Table of contents

سه راهی ۹۰ درجه مساوی تزریقی پلی اتیلن
Polyethylene Equal Tee 90°



18

لوله پلی اتیلن
Polyethylene Pipe

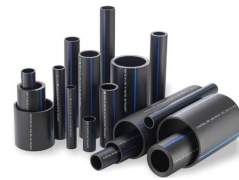

12

زانو ۹۰ درجه تزریقی پلی اتیلن
Polyethylene Elbow 90°



22

سه راهی ۹۰ درجه نامساوی تزریقی پلی اتیلن
Polyethylene Reduced Tee 90°



19

فلنج تزریقی پلی اتیلن
Polyethylene Flange Adaptor (Type A)



25

زانو ۴۵ درجه تزریقی پلی اتیلن
Polyethylene Elbow 45°



23

تبدیل هم مرکز تزریقی پلی اتیلن
Polyethylene Concentric Reducer (Long end)



29

فلنج تزریقی پلی اتیلن
Polyethylene Flange Adaptor (Type B)

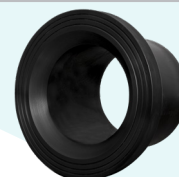

27

کپ تزریقی پلی اتیلن
Polyethylene Cap



45

تبدیل غیر هم مرکز تزریقی پلی اتیلن
Polyethylene Eccentric Reducer

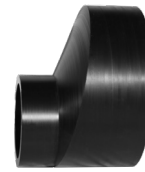

37

سه راهی ۹۰ درجه مساوی دست ساز پلی اتیلن
Polyethylene Fabricated Equal Tee 90°



55

سه راهی ۹۰ درجه نامساوی پلی اتیلن
Polyethylene Saddle Fusion Reduced Tee



48

زانوی ۹۰ درجه دست ساز پلی اتیلن
Polyethylene Fabricated Elbow 90°



59

سه راهی ۴۵ درجه مساوی دست ساز پلی اتیلن
Polyethylene Fabricated Equal Tee 45°



57

چهارراه ۹۰ درجه دست ساز پلی اتیلن
Polyethylene Fabricated Cross 90°



63

زانوی ۴۵، ۶۰ درجه دست ساز پلی اتیلن
Polyethylene Fabricated Elbow 45°, 60°



61

رینگ فولادی
Steel Back Ring (Bolt circle PN10)



69

رینگ فولادی با پوشش پلیمری تقویت شده
Steel Ring / PP Reinforced (Bolt circle PN10)



66

شیر آبریز انتهای خط
On-off valve



78

واشر تخت لاستیکی
Flat Face Rubber Gasket

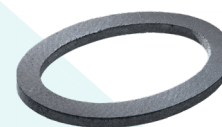

75

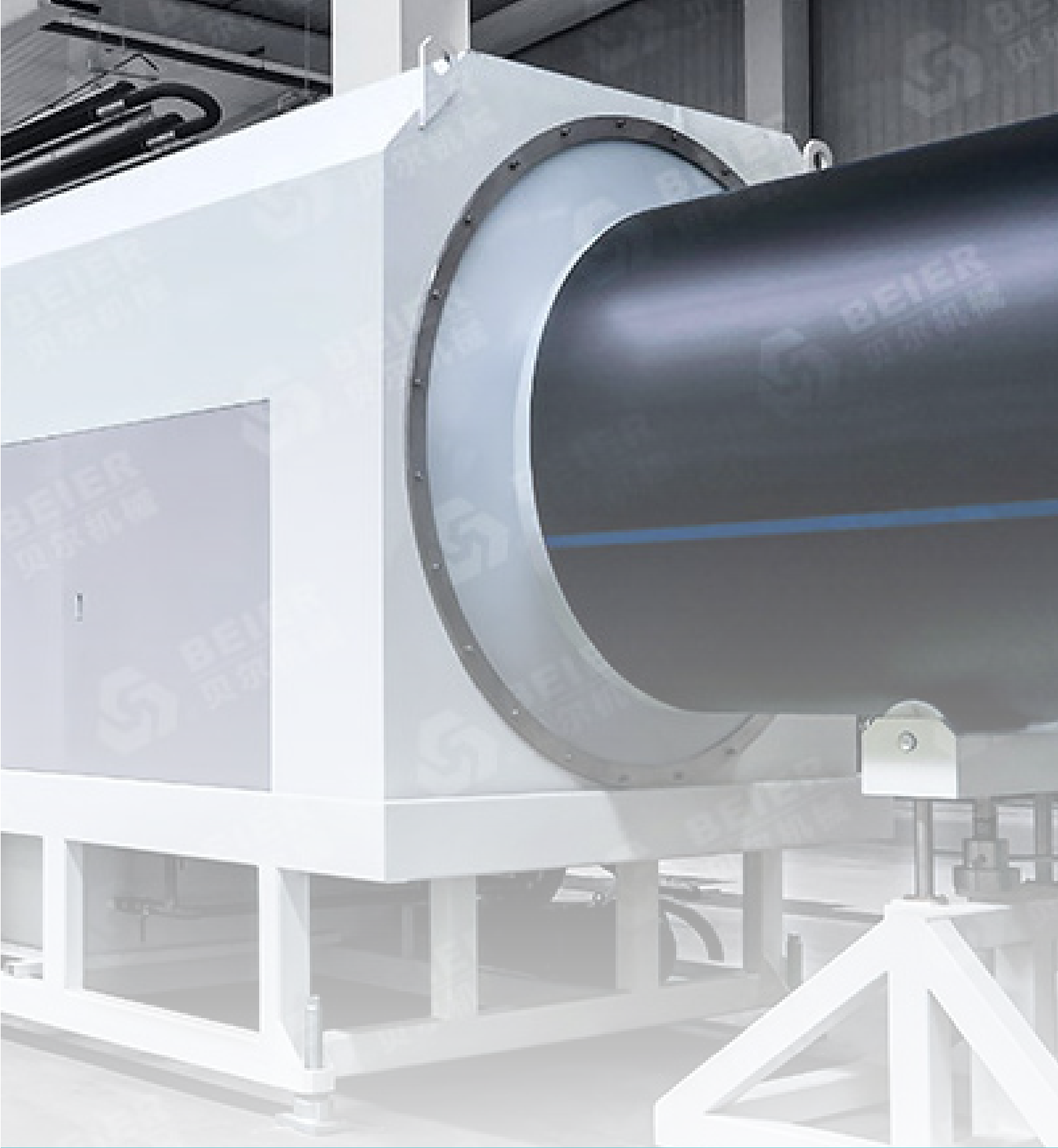



لوله پلی اتیلن Polyethylene Pipe

Polyethylene Pipe Specification

PE80/SF1.25	8.0	10.0	12.5	16.0	20.0	25.0	32.0	
PE80/SF1.60	6.3	8.0	10.0	12.5	16.0	20.0	25.0	
PE80/SF2	PN(bar)	5.0	6.3	8.0	10.0	12.5	16.0	20.0
PE100/SF1.25	10.0	12.5	16.0	20.0	25.0	32.0	40.0	
PE100/SF1.60	8.0	10.0	12.5	16.0	20.0	25.0	32.0	
PE100/SF2	6.3	8.0	10.0	12.5	16.0	20.0	25.0	

SDR	17		13.6		11		9		7.4		6		5	
dn (mm)	en mm	weight Kg/m	en mm	weight Kg/m	en mm	weight Kg/m	en mm	weight Kg/m	en mm	weight Kg/m	en mm	weight Kg/m	en mm	weight Kg/m
16	-	-	-	-	-	-	2.0	0.092	2.3	0.103	3.0	0.125	3.3	0.135
20	-	-	-	-	2.0	0.118	2.3	0.134	3.0	0.164	3.4	0.182	4.1	0.209
25	-	-	2.0	0.151	2.3	0.173	3.0	0.202	3.5	0.243	4.2	0.281	5.1	0.323
32	2.0	0.198	2.4	0.235	3.0	0.282	3.6	0.331	4.4	0.390	5.4	0.458	6.5	0.525
40	2.4	0.299	3.0	0.360	3.7	0.434	4.5	0.514	5.5	0.607	6.7	0.708	8.1	0.818
50	3.0	0.458	3.7	0.555	4.6	0.673	5.6	0.796	6.9	0.945	8.3	1.10	10.1	1.27
63	3.8	0.728	4.7	0.883	5.8	1.06	7.1	1.27	8.6	1.49	10.5	1.74	12.8	2.02
75	4.5	1.03	5.6	1.25	6.8	1.48	8.4	1.78	10.3	2.12	12.5	2.47	15.1	2.85
90	5.4	1.47	6.7	1.79	8.2	2.14	10.1	2.57	12.3	3.03	15.0	3.54	18.1	4.09
110	6.6	2.19	8.1	2.64	10.0	3.18	12.3	3.82	15.1	4.54	18.3	5.29	22.1	6.10
125	7.4	2.79	9.2	3.40	11.4	4.12	14.0	4.92	17.1	5.84	20.8	6.82	25.1	7.87
140	8.3	3.50	10.3	4.26	12.7	5.13	15.7	6.18	19.2	7.33	23.3	8.56	28.1	9.87
160	9.5	4.57	11.8	5.56	14.6	6.74	17.9	8.04	21.9	9.54	26.6	11.2	32.1	12.9
180	10.7	5.77	13.3	7.05	16.4	8.51	20.1	10.2	24.6	12.1	29.9	14.1	36.1	16.3
200	11.9	7.12	14.7	8.65	18.2	10.5	22.4	12.6	27.4	14.9	33.2	17.4	40.1	20.1
225	13.4	9.03	16.6	11.0	20.5	13.3	25.2	15.9	30.8	18.8	37.4	22.1	45.1	25.4
250	14.8	11.1	18.4	13.5	22.7	16.3	27.9	19.6	34.2	23.3	41.5	27.2	50.1	31.4
280	16.6	13.9	20.6	16.9	25.4	20.5	31.3	24.6	38.3	29.2	46.5	34.1	56.2	39.4
315	18.7	17.6	23.2	21.5	28.6	25.9	35.2	31.1	43.1	36.9	52.3	43.2	63.2	49.8
355	21.1	22.4	26.1	27.2	32.2	32.9	39.7	39.5	48.5	46.8	59.0	54.8	-	-
400	23.7	28.3	29.4	34.5	36.3	41.7	44.7	50.1	54.7	59.4	66.5	69.6	-	-
450	26.7	35.8	33.1	43.7	40.9	52.8	50.3	63.4	61.5	75.2	-	-	-	-
500	29.7	44.2	36.8	53.9	45.4	65.2	55.8	78.1	68.3	92.8	-	-	-	-
560	33.2	55.4	41.2	67.6	50.8	81.7	62.5	98.0	-	-	-	-	-	-
630	37.4	70.2	46.3	85.5	57.2	103	-	-	-	-	-	-	-	-
710	42.1	89.0	52.2	109	64.5	131	-	-	-	-	-	-	-	-
800	47.4	113	58.8	138	-	-	-	-	-	-	-	-	-	-
900	53.3	143	66.1	174	-	-	-	-	-	-	-	-	-	-
1000	59.3	176	-	-	-	-	-	-	-	-	-	-	-	-
1200	-	-	-	-	-	-	-	-	-	-	-	-	-	-

DIN 8074, INSO 14427

Polyethylene Pipe Specification

PE80/SF1.25	2.5	3.2	4.0	5.0	6.0	6.4(6.0)	7.4	
PE80/SF1.60	2.0	2.5	3.0	4.0	4.6	5.0	6.0	
PE80/SF2	PN(bar)	1.6	2.0	2.5	3.0	3.8	4.0	5.8
PE100/SF1.25	3.2	4.0	5.0	6.3(6.0)	7.4	8.0	9.6	
PE100/SF1.60	2.5	3.0	4.0	5.0	6.0	6.3	7.4	
PE100/SF2	2.0	2.5	3.0	4.0	4.8	5.0	6.0	

SDR	51		41		33		26		22		21		17.6	
dn (mm)	en mm	weight Kg/m	en mm	weight Kg/m	en mm	weight Kg/m	en mm	weight Kg/m	en mm	weight Kg/m	en mm	weight Kg/m	en mm	weight Kg/m
16	-	-	-	-	-	-	-	-	-	-	-	-	-	-
20	-	-	-	-	-	-	-	-	-	-	-	-	-	-
25	-	-	-	-	-	-	-	-	-	-	-	-	-	-
32	-	-	-	-	-	-	-	-	-	-	-	-	2.0	0.198
40	-	-	-	-	-	-	1.8	0.229	1.9	0.240	2.0	0.251	2.3	0.288
50	-	-	-	-	1.8	0.290	2.0	0.317	2.3	0.365	2.4	0.378	2.9	0.445
63	-	-	1.8	0.368	2.0	0.403	2.5	0.500	2.9	0.569	3.0	0.586	3.6	0.695
75	1.8	0.44	1.9	0.462	2.3	0.557	2.9	0.683	3.5	0.816	3.6	0.836	4.3	0.987
90	1.8	0.531	2.2	0.647	2.8	0.800	3.5	0.988	4.1	1.15	4.3	1.20	5.1	1.40
110	2.2	0.795	2.7	0.952	3.4	1.19	4.2	1.45	5.0	1.69	5.3	1.79	6.3	2.10
125	2.5	1.01	3.1	1.25	3.9	1.53	4.8	1.86	5.7	2.19	6.0	2.29	7.1	2.69
140	2.8	1.26	3.5	1.56	4.3	1.90	5.4	2.35	6.4	2.75	6.7	2.86	8.0	3.37
160	3.2	1.65	4.0	2.02	4.9	2.45	6.2	3.08	7.3	3.58	7.7	3.75	9.1	4.40
180	3.6	2.07	4.4	2.51	5.5	3.10	6.9	3.83	8.2	4.52	8.6	4.71	10.2	5.54
200	3.9	2.48	4.9	3.08	6.2	3.88	7.7	4.74	9.1	5.57	9.6	5.84	11.4	6.86
225	4.4	3.16	5.5	3.90	6.9	4.82	8.6	5.96	10.3	7.07	10.8	7.37	12.8	8.64
250	4.9	3.88	6.2	4.88	7.7	5.98	9.6	7.38	11.4	8.68	11.9	9.02	14.2	10.7
280	5.5	4.88	6.9	6.04	8.6	7.47	10.7	9.20	12.8	10.9	13.4	11.4	15.9	13.3
315	6.2	6.18	7.7	7.59	9.7	9.47	12.1	11.7	14.4	13.8	15.0	14.3	17.9	16.9
355	7.0	7.81	8.7	9.65	10.9	12.0	13.6	14.8	16.2	17.5	16.9	18.2	20.1	21.4
400	7.9	9.92	9.8	12.2	12.3	15.2	15.3	18.8	18.2	22.1	19.1	23.1	22.7	27.2
450	8.8	12.4	11.0	15.4	13.8	19.2	17.2	23.7	20.5	28.0	21.5	29.3	25.5	34.3
500	9.8	15.4	12.3	19.2	15.3	23.6	19.1	29.2	22.8	34.5	23.9	36.1	28.3	42.3
560	11.0	19.3	13.7	23.9	17.2	29.7	21.4	36.6	25.5	43.2	26.7	45.2	31.7	53.0
630	12.3	24.3	15.4	30.2	19.3	37.5	24.1	46.4	28.7	54.7	30.0	57.0	35.7	67.2
710	13.9	30.8	17.4	38.4	21.8	47.7	27.2	59.0	32.3	69.4	33.9	72.6	40.2	85.3
800	15.7	39.2	19.6	48.7	24.5	60.4	30.6	74.7	36.4	88.1	38.1	92.0	45.3	108
900	17.6	49.4	22.0	61.3	27.6	76.4	34.4	94.4	41.0	112	42.9	116	51.0	137
1000	19.6	61.1	24.5	75.9	30.6	94.1	38.2	117	45.5	138	47.7	144	56.6	169
1200	23.5	87.9	29.4	109	36.7	135	45.9	168	54.6	198	57.2	207	68.0	243

DIN 8074, INSO 14427

Dimensions in millimeter

Mean outside diameter and out-of-roundness

Nominal Size DN/OD	Nominal outside diameter	Mean outside diameter		Maximum out-of-roundness (ovality)
		d_n	$d_{em\ min}$	
16	16	16.0	16.3	1.2
20	20	20.0	20.3	1.2
25	25	25.0	25.3	1.2
32	32	32.0	32.3	1.3
40	40	40.0	40.4	1.4
50	50	50.0	50.4	1.4
63	63	63.0	63.4	1.5
75	75	75.0	75.5	1.6
90	90	90.0	90.6	1.8
110	110	110.0	110.7	2.2
125	125	125.0	125.8	2.5
140	140	140.0	140.9	2.8
160	160	160.0	161.0	3.2
180	180	180.0	181.1	3.6
200	200	200.0	201.2	4.0
225	225	225.0	226.4	4.5
250	250	250.0	251.5	5.0
280	280	280.0	281.7	9.8
315	315	315.0	316.9	11.1
355	355	355.0	357.2	12.5
400	400	400.0	402.4	14.0
450	450	450.0	452.7	15.6
500	500	500.0	503.0	17.5
560	560	560.0	563.4	19.6
630	630	630.0	633.8	22.1
710	710	710.0	716.4	24.9
800	800	800.0	807.2	28.0
900	900	900.0	908.1	-
1000	1000	1000.0	1009.0	-
1200	1200	1200.0	1210.8	-

INSO 14427, ISO4427

Dimensions in millimeter

Wall thicknesses

PE40		10	8.0	6.0	5.0	4.0	3.2	2.5							
PE80	PN(bar)	20	16	12.5	10	8.0	6.0	5.0							
PE100		25	20	16	12.5	10	8.0	6.0							
SDR		7.4	9	11	13.6	17	21	26							
d_n		e_{min}	e_{max}	e_{min}	e_{max}	e_{min}	e_{max}	e_{min}	e_{max}	e_{min}	e_{max}	e_{min}	e_{max}	e_{min}	e_{max}
16		2.3	2.7	2.0	2.3	-	-	-	-	-	-	-	-	-	-
20		3.0	3.4	2.3	2.7	2.0	2.3	-	-	-	-	-	-	-	-
25		3.5	4.0	3.0	3.4	2.3	2.7	2.0	2.3	-	-	-	-	-	-
32		4.4	5.0	3.6	4.1	3.0	3.4	2.4	2.8	2.0	2.3	-	-	-	-
40		5.5	6.2	4.5	5.1	3.7	4.2	3.0	3.5	2.4	2.8	2.0	2.3	-	-
50		6.9	7.7	5.6	6.3	4.6	5.2	3.7	4.2	3.0	3.4	2.4	2.8	2.0	2.3
63		8.6	9.6	7.1	8.0	5.8	6.5	4.7	5.3	3.8	4.3	3.0	3.4	2.5	2.9
75		10.3	11.5	8.4	9.4	6.8	7.6	5.6	6.3	4.5	5.1	3.6	4.1	2.9	3.3
90		12.3	13.7	10.1	11.3	8.2	9.2	6.7	7.5	5.4	6.1	4.3	4.9	3.5	4.0
110		15.1	16.8	12.3	13.7	10.0	11.1	8.1	9.1	6.6	7.4	5.3	6.0	4.2	4.8
125		17.1	19.0	14.0	15.6	11.4	12.7	9.2	10.3	7.4	8.3	6.0	6.7	4.8	5.4
140		19.2	21.3	15.7	17.4	12.7	14.1	10.3	11.5	8.3	9.3	6.7	7.5	5.4	6.1
160		21.9	24.2	17.9	19.8	14.6	16.2	11.8	13.1	9.5	10.6	7.7	8.6	6.2	7.0
180		24.6	27.2	20.1	22.3	16.4	18.2	13.3	14.8	10.7	11.9	8.6	9.6	6.9	7.7
200		27.4	30.3	22.4	24.8	18.2	20.2	14.7	16.3	11.9	13.2	9.6	10.7	7.7	8.6
225		30.8	34.0	25.2	27.9	20.5	22.7	16.6	18.4	13.4	14.9	10.8	12.0	8.6	9.6
250		34.2	37.8	27.9	30.8	22.7	25.1	18.4	20.4	14.8	16.4	11.9	13.2	9.6	10.7
280		38.3	42.3	31.3	34.6	25.4	28.1	20.6	22.8	16.6	18.4	13.4	14.9	10.7	11.9
315		43.1	47.6	35.2	38.9	28.6	31.6	23.2	25.7	18.7	20.7	15.0	16.6	12.1	13.5
355		48.5	53.5	39.7	43.8	32.2	35.6	26.1	28.9	21.1	23.4	16.9	18.7	13.6	15.1
400		54.7	60.3	44.7	49.3	36.3	40.1	29.4	32.5	23.7	26.2	19.1	21.2	15.3	17.0
450		61.5	67.8	50.3	55.5	40.9	45.1	33.1	36.6	26.7	29.5	21.5	23.8	17.2	19.1
500		-	-	55.8	61.5	45.4	50.1	36.8	40.6	29.7	32.8	23.9	26.4	19.1	21.2
560		-	-	62.5	68.9	50.8	56.0	41.2	45.5	33.2	36.7	26.7	29.5	21.4	23.7
630		-	-	70.3	77.5	57.2	63.1	46.3	51.1	37.4	41.3	30.0	33.1	24.1	26.7
710		-	-	79.3	87.4	64.5	71.1	52.2	57.6	42.1	46.5	33.9	37.4	27.2	30.1

INSO 14427, ISO4427





اتصالات اسپيگات (بات فيوژن) پلي اتيلن Polyethylene Spigot Fittings

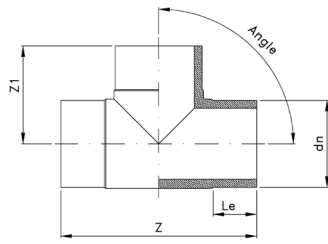

سه راهی ۹۰ درجه مساوی تزریقی پلی اتیلن
 Polyethylene Equal Tee 90°
 تی البولی إیتیلین المتساویة ۹۰ درجه
 Литые Тройники Соединительные 90°

Dimensions in millimeter

d_n	Code	Z	Z ₁	Le
63	60227 0606 x 1	210	105	65
75	60227 0707 x 1	250	125	72
90	60227 0909 x 1	270	135	75
110	60227 1111 x 1	320	160	85
125	60227 1212 x 1	350	175	90
160	60227 1616 x 1	400	200	100
200	60227 2020 x 1	480	240	110
250	60227 2525 x 1	550	275	120
315	60227 3131 x 1	590	300	120
355	60227 3535 x 1	700	350	135
400	60227 4040 x 1	750	375	140
450	60227 4545 x 1	800	400	145
500	60227 5050 x 1	830	415	150

Material: HDPE 100

INSO 14427, ISO 4427

Length tolerance: $d_n \leq 315\text{mm}$: $\pm 2\text{ mm}$ and
 above 315 mm: $\pm 5\text{ mm}$

Determine x of product code according to following table:

SDR	26	21	17	13.6	11	9	7.4
X	3	4	5	6	7	8	9

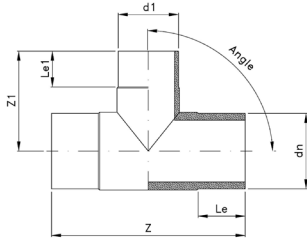

سه راهی ۹۰ درجه نامساوی تزریقی پلی اتیلن
 Polyethylene Reduced Tee 90°
 تی نقاص البولی ایتیلین ۹۰ درجه
 Литые Тройники Переходные 90°

Dimensions in millimeter

d_n	d_1	Code	Z	Z_1	L_e	L_{e1}
63	50	60227 0605 x 1	210	100	65	60
75	63	60227 0706 x 1	250	120	72	67
75	50	60227 0705 x 1	250	115	72	62
90	75	60227 0907 x 1	270	132	75	72
90	63	60227 0906 x 1	270	130	75	70
110	90	60227 1109 x 1	320	155	85	80
110	75	60227 1107 x 1	320	150	85	75
110	63	60227 1106 x 1	320	145	85	70
125	110	60227 1211 x 1	350	170	90	85
125	90	60227 1209 x 1	350	165	90	80
125	75	60227 1207 x 1	350	160	90	75
125	63	60227 1206 x 1	350	155	90	70
160	125	60227 1612 x 1	400	195	100	90
160	110	60227 1611 x 1	400	190	100	85
160	90	60227 1609 x 1	330	180	100	80
160	75	60227 1607 x 1	330	175	100	75
160	63	60227 1606 x 1	330	170	100	70

Material: HDPE 100
 INSO 14427, ISO 4427

Length tolerance: $d_n \leq 315\text{mm}$: ± 2 mm and
 above 315 mm: ± 5 mm

Determine x of product code according to following table:

SDR	26	21	17	13.6	11	9	7.4
X	3	4	5	6	7	8	9

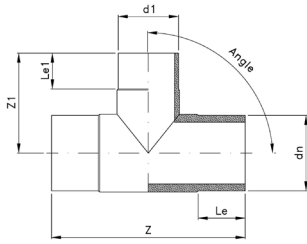

سه راهی ۹۰ درجه نامساوی تزریقی پلی اتیلن
 Polyethylene Reduced Tee 90°
 تی نقاص البولی ایثیلین ۹۰ درجه
 Литые Тройники Переходные 90°

Dimensions in millimeter

d_n	d_1	Code	Z	Z_1	L_e	L_{e1}
200	160	60227 2016 x 1	480	230	110	100
200	125	60227 2012 x 1	380	220	110	90
200	110	60227 2011 x 1	380	215	110	85
200	90	60227 2009 x 1	380	210	110	80
200	75	60227 2007 x 1	380	205	110	75
200	63	60227 2006 x 1	380	200	110	70
250	200	60227 2520x 1	550	270	120	110
250	160	60227 2516 x 1	440	255	120	100
250	125	60227 2512 x 1	440	250	120	95
250	110	60227 2511 x 1	440	245	120	90
250	90	60227 2509 x 1	440	240	120	85
250	75	60227 2507 x 1	440	235	120	80
250	63	60227 2506 x 1	440	230	120	75
315	250	60227 3125 x 1	560	300	130	125
315	225	60227 3122 x 1	560	295	130	120
315	200	60227 3120 x 1	560	290	130	115
315	160	60227 3116 x 1	470	285	130	110

Material: HDPE 100
 INSO 14427, ISO 4427

Length tolerance: $d_n \leq 315\text{mm}$: ± 2 mm and
 above 315 mm: ± 5 mm

Determine x of product code according to following table:

SDR	26	21	17	13.6	11	9	7.4
X	3	4	5	6	7	8	9

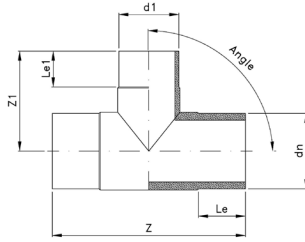

سه راهی ۹۰ درجه نامساوی تزریقی پلی اتیلن
 Polyethylene Reduced Tee 90°
 تی نقاص البولی ایثنیلین ۹۰ درجه
 Литые Тройники Переходные⁰

Dimensions in millimeter

d_n	d_1	Code	Z	Z_1	L_e	L_{e1}
315	140	60227 3114 x 1	470	275	130	100
315	125	60227 3112 x 1	470	265	130	90
315	110	60227 3111 x 1	470	260	130	85
355	200	60227 3520 x 1	520	320	135	115
355	160	60227 3516 x 1	520	315	135	110
400	250	60227 4025 x 1	580	350	140	125
400	225	60227 4022 x 1	580	345	140	120
400	200	60227 4020 x 1	580	340	140	115
450	250	60227 4525 x 1	590	375	145	125
450	225	60227 4522 x 1	590	370	145	120
450	200	60227 4520 x 1	590	365	145	115
500	315	60227 5031 x 1	670	405	150	130
500	280	60227 5028 x 1	670	400	150	125
500	250	60227 5025 x 1	670	400	150	125

Material: HDPE 100
 INSO 14427, ISO 4427

Length tolerance: $d_n \leq 315\text{mm}$: ± 2 mm and
 above 315 mm: ± 5 mm

Determine x of product code according to following table:

SDR	26	21	17	13.6	11	9	7.4
X	3	4	5	6	7	8	9

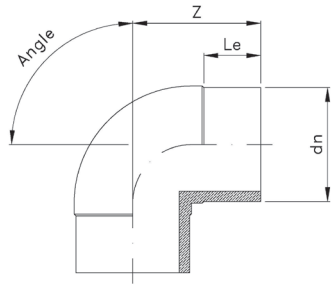

زانو ۹۰ درجه تزریقی پلی اتیلن
 Polyethylene Elbow 90°
 ركبة البولي إيثيلين ۹۰ درجة
 Литые Отвод 90°

Dimensions in millimeter

d_n	Code	Z	L_e
63	60228 0690 x 1	110	65
75	60228 0790 x 1	130	75
90	60228 0990 x 1	145	80
110	60228 1190 x 1	158	85
125	60228 1290 x 1	175	90
160	60228 1690 x 1	215	110
200	60228 2090 x 1	255	125
250	60228 2590 x 1	290	130
315	60228 3190 x 1	318	120

Material: HDPE 100
 INSO 14427, ISO 4427
 Length tolerance: ± 2 mm

Determine x of product code according to following table:

SDR	26	21	17	13.6	11	9	7.4
X	3	4	5	6	7	8	9

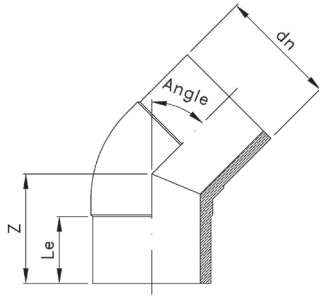

زانو ۴۵ درجه تزریقی پلی اتیلن
 Polyethylene Elbow 45°
 ركبۀ البولى إيثيلين ۴۵ درجۀ
 Литые Отвод 45°

Dimensions in millimeter

d_n	Code	Z	L_e
63	60228 0645 x 1	90	65
75	60228 0745 x 1	100	72
90	60228 0945 x 1	115	80
110	60228 1145 x 1	125	85
125	60228 1245 x 1	135	90
160	60228 1645 x 1	160	110
200	60228 2045 x 1	190	120
250	60228 2545 x 1	210	130
315	60228 3145 x 1	215	120

Material: HDPE 100
 INSO 14427, ISO 4427
 Length tolerance: ± 2 mm

Determine x of product code according to following table:

SDR	26	21	17	13.6	11	9	7.4
X	3	4	5	6	7	8	9

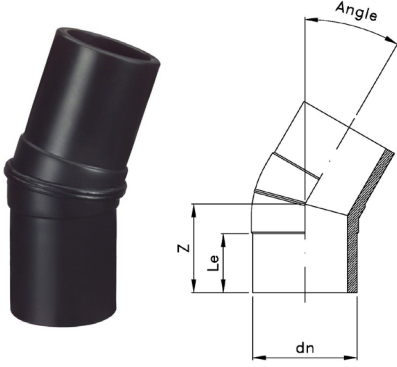

زانو ۱۱،۲۵ ، ۲۲،۵ ، ۳۰ درجه جوشی / تزریقی پلی اتیلن
Polyethylene Elbow 11.25°, 22.5°, 30°

ركبة البولي إيثيلين ۱۱،۲۵ ، ۲۲،۵ و ۳۰ درجة
Литые Отвод 11.25°, 22.5°, 30°

Dimensions in millimeter

d _n	Code			L _e	Z
	11.25°	22.5°	30°		
63	60238 0611 x 1	60238 0622 x 1	60238 0630 x 1	65	85
75	60238 0711 x 1	60238 0722 x 1	60238 0730 x 1	72	95
90	60238 0911 x 1	60238 0922 x 1	60238 0930 x 1	80	110
110	60238 1111 x 1	60238 1122 x 1	60238 1130 x 1	85	120
125	60238 1211 x 1	60238 1222 x 1	60238 1230 x 1	90	130
160	60238 1611 x 1	60238 1622 x 1	60238 1630 x 1	110	150
200	60238 2011 x 1	60238 2022 x 1	60238 2030 x 1	120	180
250	60238 2511 x 1	60238 2522 x 1	60238 2530 x 1	130	200
315	60238 3111 x 1	60238 3122 x 1	60238 3130 x 1	120	205

Material: HDPE 100
INSO 14427, ISO 4427
Length tolerance: ± 2 mm
 $\alpha = \pm 2^\circ$

Determine x of product code according to following table:

SDR	26	21	17	13.6	11	9	7.4
X	3	4	5	6	7	8	9

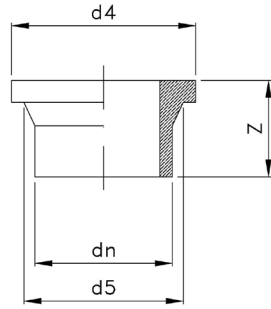

فلنج تزریقی پلی اتیلن
Polyethylene Flange Adaptor (Type A)
شفة البولى إيثيلين
Литые Фланцы

Dimensions in millimeter

d _n	Code		d ₄	d ₅	Z	
	Short	Long			Short	Long
63	60201 0600 x 1	60201 0602 x 1	102	75	59	110
75	60201 0700 x 1	60201 0702 x 1	122	89	63	110
90	60201 0900 x 1	60201 0902 x 1	138	105	81	120
110	60201 1100 x 1	60201 1102 x 1	158	125	84	129
125	60201 1200 x 1	60201 1202 x 1	178	132	88	140
140	60201 1400 x 1	60201 1402 x 1	188	155	100	160
160	60201 1600 x 1	60201 1602 x 1	212	175	105	165
180	60201 1800 x 1	60201 1802 x 1	212	183	110	180
200	60201 2000 x 1	60201 2002 x 1	268	232	130	185
225	60201 2200 x 1	60201 2202 x 1	268	235	120	190
250	60201 2500 x 1	60201 2502 x 1	320	285	120	195
280	60201 2800 x 1	60201 2802 x 1	320	291	120	200
315	60201 3100 x 1	60201 3102 x 1	370	335	120	225
355	60201 3500 x 1	60201 3502 x 1	430	373	130	200
400	60201 4000 x 1	60201 4002 x 1	482	427	140	200

Material: HDPE 100
INSO 17303, ISO 9624

Length tolerance: dn ≤ 315mm: ± 2 mm and
above 315 mm: ± 5 mm

Determine x of product code according to following table:

SDR	26	21	17	13.6	11	9	7.4
X	3	4	5	6	7	8	9

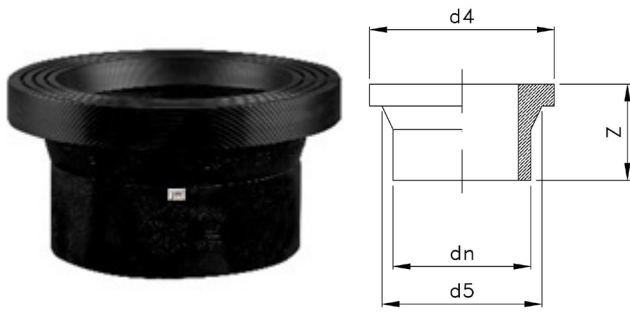

فلنج تزریقى پلی اتیلن
 Polyethylene Flange Adaptor (Type A)

شفة البولى إتیلین
 Литые Фланцы

Dimensions in millimeter

d _n	Code		d ₄	d ₅	Z	
	Short	Long			Short	Long
450(450)	60201 4500 x 1	60201 4502 x 1	535	514	150	200
450(500)	60201 4503 x 1	60201 4523 x 1	585	514	150	200
500	60201 5000 x 1	60201 5002 x 1	585	530	150	200
560	60201 5600 x 1	60201 5602 x 1	685	615	155	200
630	60201 6300 x 1	60201 6302 x 1	685	642	160	200
710	60201 7100 x 1	60201 7102 x 1	800	737	170	220
800	60201 8000 x 1	60201 8002 x 1	905	840	180	230
900	60201 9000 x 1	60201 9002 x 1	1005	944	190	240
1000	60201 1000 x 1	60201 1002 x 1	1110	1047	200	250
1200	60201 9200 x 1	60201 9202 x 1	1330	1245	210	270

Material: HDPE 100

INSO 17303, ISO 9624

Length tolerance: dn ≤ 315mm: ± 2 mm and
 above 315 mm: ± 5 mm

Determine x of product code according to following table:

SDR	26	21	17	13.6	11	9	7.4
X	3	4	5	6	7	8	9

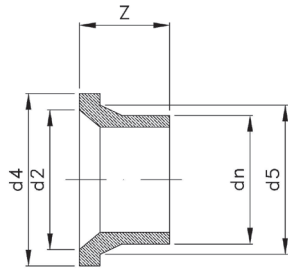

فلنج تزریقی پلی اتیلن
 Polyethylene Flange Adaptor (Type B)

شفة البولى إيثيلين
 Литые Фланцы

Dimensions in millimeter

d _n	Code		d ₄	d ₅	d ₂	Z	
	Short	Long				Short	Long
63	60201 0601 x 1	60201 0611 x 1	102	75	-	59	110
75	60201 0701 x 1	60201 0711 x 1	122	89	66	63	110
90	60201 0901 x 1	60201 0911 x 1	138	105	78	81	120
110	60201 1101 x 1	60201 1111 x 1	158	125	100	84	129
125	60201 1201 x 1	60201 1211 x 1	178	132	114	88	135
140	60201 1401 x 1	60201 1411 x 1	188	155	127	100	160
160	60201 1601 x 1	60201 1611 x 1	212	175	151	105	165
180	60201 1801 x 1	60201 1811 x 1	212	183	158	110	180
200	60201 2001 x 1	60201 2011 x 1	268	232	203	130	185
225	60201 2201 x 1	60201 2211 x 1	268	235	210	120	200
250	60201 2501 x 1	60201 2511 x 1	320	285	245	120	195
280	60201 2801 x 1	60201 2811 x 1	320	291	265	120	200
315	60201 3101 x 1	60201 3111 x 1	370	335	300	120	200
355	60201 3501 x 1	60201 3511 x 1	430	373	340	130	200
400	60201 4001 x 1	60201 4011 x 1	482	427	385	140	200

Material: HDPE 100

INSO 17303, ISO 9624

Length tolerance: dn ≤ 315mm: ± 2 mm and
 above 315 mm: ± 5 mm

Suitable for butterfly valve

Determine x of product code according to following table:

SDR	26	21	17	13.6	11	9	7.4
X	3	4	5	6	7	8	9

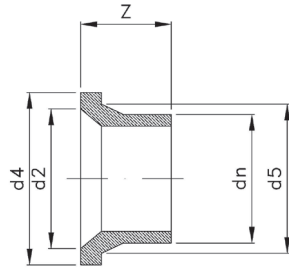

فلنج تزریقی پلی اتیلن
 Polyethylene Flange Adaptor (Type B)

شفة البولى إیتیلین
 Литые Фланцы

Dimensions in millimeter

d_n	Code		d_4	d_5	d_2	Z	
	Short	Long				Short	Long
450(450)	60201 4501 x 1	60201 4511 x 1	538	514	400	150	200
500(450)	60201 4533 x 1	60201 4523 x 1	585	514	400	150	200
500	60201 5001 x 1	60201 5011 x 1	585	530	497	150	200
560	60201 5601 x 1	60201 5611 x 1	685	615	490	155	200
630	60201 6301 x 1	60201 6311 x 1	685	642	545	160	200
710	60201 7101 x 1	60201 7111 x 1	800	737	-	170	220
800	60201 8001 x 1	60201 8011 x 1	905	840	-	180	230
900	60201 9001 x 1	60201 9011 x 1	1005	944	-	190	240
1000	60201 1001 x 1	60201 1011 x 1	1110	1047	-	200	250
1200	60201 9201 x 1	60201 9211 x 1	1330	1245	-	210	270

Material: HDPE 100

INSO 17303, ISO 9624

Length tolerance: $d_n \leq 315\text{mm}$: $\pm 2\text{ mm}$ and
 above 315 mm: $\pm 5\text{ mm}$

Suitable for butterfly valve

Determine x of product code according to following table:

SDR	26	21	17	13.6	11	9	7.4
X	3	4	5	6	7	8	9

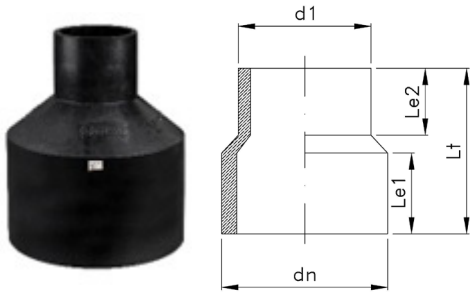

تبدیل هم مرکز تزریقی پلی اتیلن
 Polyethylene Concentric Reducer (Long end)

محول البولى إيثيلين متحد المركز
 Литые Одноступенчатые Переходники

Dimensions in millimeter

d_n	d_1	Code	L_{e1}	L_{e2}	L_t
75	50	60202 0705 x 1	70	55	150
75	63	60202 0706 x 1	70	63	150
90	63	60202 0906 x 1	80	63	165
90	75	60202 0907 x 1	80	70	165
110	63	60202 1106 x 1	85	65	180
110	75	60202 1107 x 1	85	70	180
110	90	60202 1109 x 1	85	79	180
125	63	60202 1206 x 1	90	65	195
125	75	60202 1207 x 1	90	70	195
125	90	60202 1209 x 1	90	79	195
125	110	60202 1211 x 1	90	82	195
140	63	60202 1406 x 1	92	63	195
140	75	60202 1407 x 1	92	70	195
140	90	60202 1409 x 1	92	79	195
140	110	60202 1411 x 1	92	82	195
140	125	60202 1412 x 1	92	87	195
160	63	60202 1606 x 1	100	65	215

Material: HDPE 100
 INSO 14427, ISO 4427

Length tolerance: $d_n \leq 315\text{mm}$: ± 3 mm and
 above 315 mm: ± 10 mm

Determine x of product code according to following table:

SDR	26	21	17	13.6	11	9	7.4
X	3	4	5	6	7	8	9

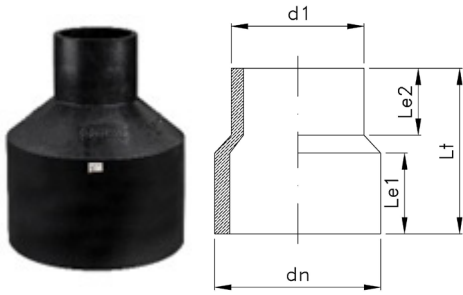

تبدیل هم مرکز تزریقی پلی اتیلن
 Polyethylene Concentric Reducer (Long end)

محول البولى إيثيلين متحد المركز
 Литые Одноступенчатые Переходники

Dimensions in millimeter

d_n	d_1	Code	L_{e1}	L_{e2}	L_t
160	75	60202 1607 x 1	100	70	215
160	90	60202 1609 x 1	100	79	210
160	110	60202 1610 x 1	100	82	210
160	125	60202 1612 x 1	100	87	210
160	140	60202 1614 x 1	100	92	210
180	63	60202 1806 x 1	105	63	215
180	75	60202 1807 x 1	105	70	215
180	90	60202 1809 x 1	105	79	215
180	110	60202 1810 x 1	105	82	215
180	125	60202 1812 x 1	105	87	215
180	160	60202 1816 x 1	105	98	215
200	63	60202 2006 x 1	115	63	235
200	75	60202 2007 x 1	115	70	235
200	90	60202 2009 x 1	115	79	235
200	110	60202 2011 x 1	115	82	235
200	125	60202 2012 x 1	115	87	235
200	160	60202 2016 x 1	115	98	235

Material: HDPE 100
 INSO 14427, ISO 4427

Length tolerance: $d_n \leq 315\text{mm}$: ± 3 mm and
 above 315 mm: ± 10 mm

Determine x of product code according to following table:

SDR	26	21	17	13.6	11	9	7.4
X	3	4	5	6	7	8	9

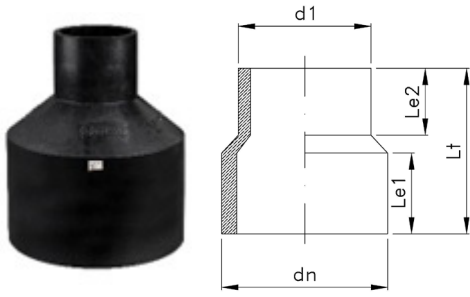

تبدیل هم مرکز تزریقی پلی اتیلن
 Polyethylene Concentric Reducer (Long end)

محول البولى إيثيلين متحد المركز
 Литые Одноступенчатые Переходники

Dimensions in millimeter

d_n	d_1	Code	L_{e1}	L_{e2}	L_t
200	180	60202 2018 x 1	115	105	235
225	63	60202 2206 x 1	120	63	240
225	75	60202 2207 x 1	120	70	240
225	90	60202 2209 x 1	120	79	240
225	110	60202 2211 x 1	120	82	240
225	125	60202 2212 x 1	120	87	240
225	140	60202 2214 x 1	120	92	240
225	160	60202 2216 x 1	120	98	240
225	180	60202 2218 x 1	120	105	240
225	200	60202 2220 x 1	120	112	240
250	63	60202 2506 x 1	130	63	260
250	75	60202 2507 x 1	130	70	260
250	90	60202 2509 x 1	130	80	260
250	110	60202 2511 x 1	130	85	260
250	125	60202 2512 x 1	130	90	260
250	160	60202 2516 x 1	130	100	260
250	200	60202 2520 x 1	130	115	265
250	225	60202 2522 x 1	130	120	270

Material: HDPE 100
 INSO 14427, ISO 4427

Length tolerance: $d_n \leq 315\text{mm}$: ± 3 mm and
 above 315 mm: ± 10 mm

Determine x of product code according to following table:

SDR	26	21	17	13.6	11	9	7.4
X	3	4	5	6	7	8	9

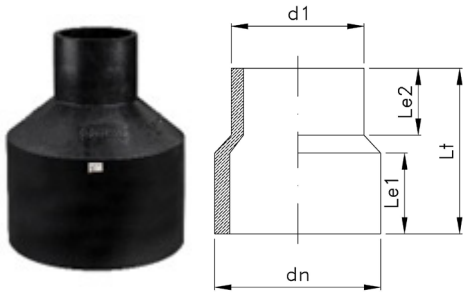

تبدیل هم مرکز تزریقی پلی اتیلن
 Polyethylene Concentric Reducer (Long end)

محول البولی ایٹیلین متحد المركز
 Литые Одноступенчатые Переходники

Dimensions in millimeter

d_n	d_1	Code	Le_1	Le_2	L_t
280	90	60202 2809 x 1	100	75	220
280	110	60202 2811 x 1	100	80	220
280	125	60202 2812 x 1	100	80	220
280	160	60202 2816 x 1	100	85	220
280	200	60202 2820 x 1	100	90	220
280	225	60202 2822 x 1	100	95	220
280	250	60202 2825 x 1	100	100	220
315	90	60202 3109 x 1	100	80	230
315	110	60202 3111 x 1	100	85	230
315	125	60202 3112 x 1	100	90	230
315	160	60202 3116 x 1	100	100	240
315	200	60202 3120 x 1	100	100	240
315	225	60202 3122 x 1	100	100	240
315	250	60202 3125 x 1	120	110	250
315	280	60202 3128 x 1	120	110	250
355	90	60202 3509 x 1	100	70	240
355	110	60202 3511 x 1	100	85	240

Material: HDPE 100
 INSO 14427, ISO 4427

Length tolerance: $d_n \leq 315\text{mm}$: ± 3 mm and
 above 315 mm: ± 10 mm

Determine x of product code according to following table:

SDR	26	21	17	13.6	11	9	7.4
X	3	4	5	6	7	8	9

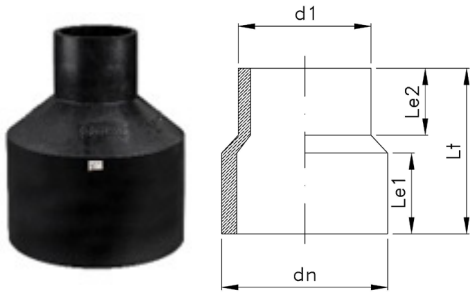

تبدیل هم مرکز تزریقی پلی اتیلن
 Polyethylene Concentric Reducer (Long end)

محول البولى إيثيلين متحد المركز
 Литые Одноступенчатые Переходники

Dimensions in millimeter

d_n	d_1	Code	L_{e1}	L_{e2}	L_t
355	125	60202 3512 x 1	110	85	250
355	160	60202 3516 x 1	110	90	250
355	200	60202 3520 x 1	110	100	250
355	225	60202 3522 x 1	110	100	250
355	250	60202 3525 x 1	110	105	250
355	315	60202 3531 x 1	110	110	250
400	90	60202 4009 x 1	110	80	250
400	110	60202 4011 x 1	110	80	250
400	125	60202 4012 x 1	110	85	250
400	160	60202 4016 x 1	110	90	250
400	200	60202 4020 x 1	110	105	260
400	225	60202 4022 x 1	110	105	260
400	250	60202 4025 x 1	110	105	260
400	315	60202 4031 x 1	120	110	270
400	355	60202 4035 x 1	120	115	270
450	110	60202 4511 x 1	100	85	260

Material: HDPE 100
 INSO 14427, ISO 4427

Length tolerance: $d_n \leq 315\text{mm}$: ± 3 mm and
 above 315 mm: ± 10 mm

Determine x of product code according to following table:

SDR	26	21	17	13.6	11	9	7.4
X	3	4	5	6	7	8	9

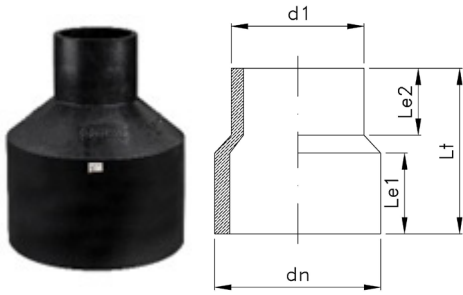

تبدیل هم مرکز تزریقی پلی اتیلن
 Polyethylene Concentric Reducer (Long end)

محول البولی ایٹیلین متحد المركز
 Литые Одноступенчатые Переходники

Dimensions in millimeter

d_n	d_1	Code	L_{e1}	L_{e2}	L_t
450	125	60202 4512 x 1	100	90	260
450	160	60202 4516 x 1	110	100	270
450	200	60202 4520 x 1	110	100	270
450	225	60202 4522 x 1	110	100	260
450	250	60202 4525 x 1	120	100	270
450	280	60202 4528 x 1	120	120	280
450	315	60202 4531 x 1	120	120	275
450	355	60202 4535 x 1	120	120	270
500	200	60202 5020 x 1	105	100	250
500	225	60202 5022 x 1	105	100	250
500	250	60202 5025 x 1	105	100	250
500	315	60202 5031 x 1	105	100	250
500	355	60202 5035 x 1	110	110	260
500	400	60202 5040 x 1	110	110	255
500	450	60202 5045 x 1	120	110	260
560	200	60202 5620 x 1	110	100	260
560	225	60202 5622 x 1	110	100	260

Material: HDPE 100
 INSO 14427, ISO 4427

Length tolerance: $d_n \leq 315\text{mm}$: ± 3 mm and
 above 315 mm: ± 10 mm

Determine x of product code according to following table:

SDR	26	21	17	13.6	11	9	7.4
X	3	4	5	6	7	8	9

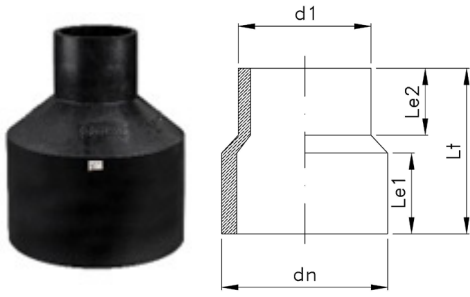

تبدیل هم مرکز تزریقی پلی اتیلن
Polyethylene Concentric Reducer (Long end)

محول البولى إيثيلين متحد المركز
Литые Одноступенчатые Переходники

Dimensions in millimeter

d_n	d_1	Code	L_{e1}	L_{e2}	L_t
560	250	60202 5625 x 1	110	100	260
560	315	60202 5631 x 1	120	100	270
560	355	60202 5635 x 1	120	105	270
560	400	60202 5640 x 1	120	110	270
560	450	60202 5645 x 1	120	115	270
560	500	60202 5650 x 1	120	120	270
630	200	60202 6320 x 1	120	100	270
630	225	60202 6322 x 1	120	100	270
630	250	60202 6325 x 1	120	100	270
630	315	60202 6331 x 1	120	110	270
630	355	60202 6335 x 1	120	110	270
630	400	60202 6340 x 1	120	115	270
630	450	60202 6345 x 1	120	115	270
630	500	60202 6350 x 1	120	115	270
630	560	60202 6356 x 1	120	115	270
710	200	60202 7120 x 1	120	100	270
710	225	60202 7122 x 1	120	100	270
710	250	60202 7125 x 1	120	100	270

Material: HDPE 100
INSO 14427, ISO 4427

Length tolerance: $d_n \leq 315\text{mm}$: ± 3 mm and
above 315 mm: ± 10 mm

Determine x of product code according to following table:

SDR	26	21	17	13.6	11	9	7.4
X	3	4	5	6	7	8	9

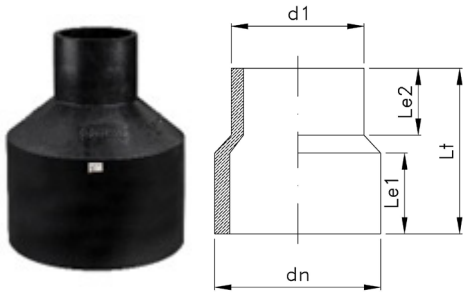

تبدیل هم مرکز تزریقی پلی اتیلن
 Polyethylene Concentric Reducer (Long end)

محول البولى إيثيلين متحد المركز
 Литые Одноступенчатые Переходники

Dimensions in millimeter

d_n	d_1	Code	L_{e1}	L_{e2}	L_t
710	315	60202 7131 x 1	120	100	270
710	355	60202 7135 x 1	130	100	280
710	400	60202 7140 x 1	130	100	280
710	450	60202 7145 x 1	130	105	280
710	500	60202 7150 x 1	130	110	280
710	560	60202 7156 x 1	130	115	280
710	630	60202 7163 x 1	130	120	280
800	200	60202 8020 x 1	130	100	285
800	225	60202 8022 x 1	130	100	285
800	250	60202 8025 x 1	130	100	285
800	315	60202 8031 x 1	130	100	285
800	355	60202 8035 x 1	135	100	290
800	400	60202 8040 x 1	135	105	290
800	450	60202 8045 x 1	135	110	290
800	500	60202 8050 x 1	140	115	290
800	560	60202 8056 x 1	140	115	290
800	630	60202 8063 x 1	140	115	290
800	710	60202 8071 x 1	140	120	290

Material: HDPE 100

INSO 14427, ISO 4427

Length tolerance: $d_n \leq 315\text{mm}$: ± 3 mm and
 above 315 mm: ± 10 mm

Producing up to 1400mm is possible

Determine x of product code according to following table:

SDR	26	21	17	13.6	11	9	7.4
X	3	4	5	6	7	8	9

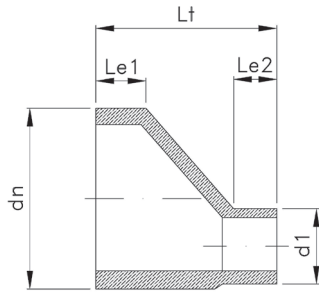

تبدیل غیر هم مرکز تزریقی پلی اتیلن
 Polyethylene Eccentric Reducer

محول البولى إيثيلين مختلف المركز
 Длинные эксцентрические переходники

Dimensions in millimeter

d_n	d_1	Code	Le_1	Le_2	L_t
63	50	60203 0605 x 1	63	55	140
75	50	60203 0705 x 1	70	55	150
75	63	60203 0706 x 1	70	63	150
90	50	60203 0905 x 1	79	55	170
90	63	60203 0906 x 1	79	63	170
90	75	60203 0907 x 1	79	70	170
110	63	60203 1106 x 1	82	63	190
110	75	60203 1107 x 1	82	70	190
110	90	60203 1109 x 1	82	79	190
125	63	60203 1206 x 1	87	63	200
125	75	60203 1207 x 1	87	70	200
125	90	60203 1209 x 1	87	79	200
125	110	60203 1211 x 1	87	82	200
140	63	60203 1406 x 1	92	63	210
140	75	60203 1407 x 1	92	70	210
140	90	60203 1409 x 1	92	79	210
140	110	60203 1411 x 1	92	82	210
140	125	60203 1412 x 1	92	87	210

Material: HDPE 100
 INSO 14427, ISO 4427

Length tolerance: $d_n \leq 315\text{mm}$: ± 10 mm and
 above 315 mm: ± 20 mm

Determine x of product code according to following table:

SDR	26	21	17	13.6	11	9	7.4
X	3	4	5	6	7	8	9

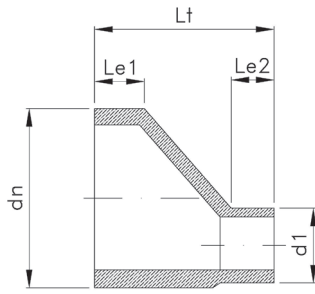

تبدیل غیر هم مرکز تزریقی پلی اتیلن
Polyethylene Eccentric Reducer

محول البولی ایتیلین مختلف المركز
Длинные эксцентрисческие переходники

Dimensions in millimeter

d_n	d_1	Code	L_{e1}	L_{e2}	L_t
160	63	60203 1606 x 1	98	63	220
160	75	60203 1607 x 1	98	70	220
160	90	60203 1609 x 1	98	79	220
160	110	60203 1611 x 1	98	82	220
160	125	60203 1612 x 1	98	87	220
160	140	60203 1614 x 1	98	92	220
180	63	60203 1806 x 1	85	65	190
180	75	60203 1807 x 1	85	70	195
180	90	60203 1809 x 1	85	80	200
180	110	60203 1811 x 1	85	85	200
180	125	60203 1812 x 1	85	85	200
180	160	60203 1816 x 1	85	85	200
200	63	60203 2006 x 1	90	65	200
200	75	60203 2007 x 1	90	70	200
200	90	60203 2009 x 1	90	80	210
200	110	60203 2011 x 1	90	85	210
200	125	60203 2012 x 1	90	90	210
200	160	60203 2016 x 1	90	90	210

Material: HDPE 100

INSO 14427, ISO 4427

Length tolerance: $d_n \leq 315\text{mm}$: $\pm 10\text{ mm}$ and
above 315 mm: $\pm 20\text{ mm}$

Determine x of product code according to following table:

SDR	26	21	17	13.6	11	9	7.4
X	3	4	5	6	7	8	9

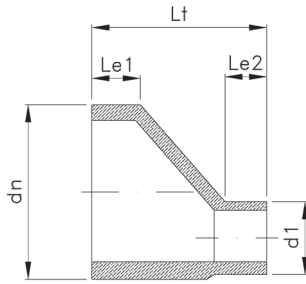

تبدیل غیر هم مرکز تزریقی پلی اتیلن
 Polyethylene Eccentric Reducer

محول البولى إثیلین مختلف المركز
 Длинные эксцентрические переходники

Dimensions in millimeter

d_n	d_1	Code	Le_1	Le_2	L_t
200	180	60203 2018 x 1	90	90	210
225	63	60203 2206 x 1	100	65	210
225	75	60203 2207 x 1	100	70	210
225	90	60203 2209 x 1	100	80	220
225	110	60203 2211 x 1	100	85	220
225	125	60203 2212 x 1	100	90	220
225	160	60203 2216 x 1	100	90	220
225	180	60203 2218 x 1	100	90	220
225	200	60203 2220 x 1	100	90	220
250	63	60203 2506 x 1	125	65	250
250	75	60203 2507 x 1	125	70	250
250	90	60203 2509 x 1	125	80	260
250	110	60203 2511 x 1	125	85	270
250	125	60203 2512 x 1	125	90	270
250	160	60203 2516 x 1	125	90	270
250	200	60203 2520 x 1	125	90	270
250	225	60203 2522 x 1	125	100	270
280	90	60203 2809 x 1	100	80	240

Material: HDPE 100

INSO 14427, ISO 4427

Length tolerance: $d_n \leq 315\text{mm}$: ± 10 mm and
 above 315 mm: ± 20 mm

Determine x of product code according to following table:

SDR	26	21	17	13.6	11	9	7.4
X	3	4	5	6	7	8	9

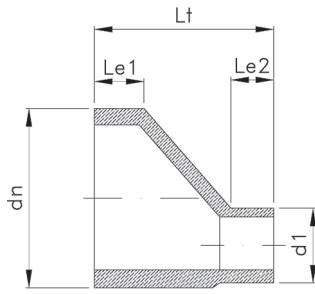

تبدیل غیر هم مرکز تزریقی پلی اتیلن
 Polyethylene Eccentric Reducer

محول البولي إيثيلين مختلف المركز
 Длинные эксцентрические переходники

Dimensions in millimeter

d_n	d_1	Code	L_{e1}	L_{e2}	L_t
280	110	60203 2811 x 1	100	85	250
280	125	60203 2812 x 1	100	90	250
280	160	60203 2816 x 1	100	90	250
280	200	60203 2820 x 1	100	90	250
280	225	60203 2822 x 1	100	100	250
280	250	60203 2825 x 1	100	100	250
315	90	60203 3109 x 1	150	80	300
315	110	60203 3111 x 1	150	85	300
315	125	60203 3112 x 1	150	90	310
315	160	60203 3116 x 1	150	100	320
315	200	60203 3120 x 1	150	115	330
315	225	60203 3122 x 1	150	120	340
315	250	60203 3125 x 1	150	130	350
315	280	60203 3128 x 1	150	140	350
355	90	60203 3509 x 1	150	80	300
355	110	60203 3511 x 1	150	85	300
355	125	60203 3512 x 1	150	90	310
355	160	60203 3516 x 1	150	100	320

Material: HDPE 100

INSO 14427, ISO 4427

Length tolerance: $d_n \leq 315\text{mm}$: $\pm 10\text{ mm}$ and
 above 315 mm: $\pm 20\text{ mm}$

Determine x of product code according to following table:

SDR	26	21	17	13.6	11	9	7.4
X	3	4	5	6	7	8	9

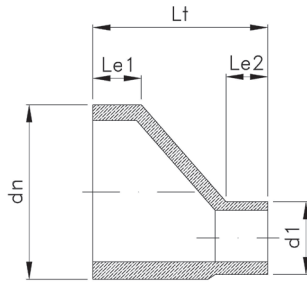
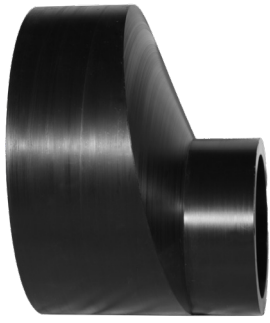

تبدیل غیر هم مرکز تزریقی پلی اتیلن
 Polyethylene Eccentric Reducer

محول البولى إيثيلين مختلف المركز
 Длинные эксцентрические переходники

Dimensions in millimeter

d_n	d_1	Code	L_{e1}	L_{e2}	L_t
355	200	60203 3520 x 1	150	115	330
355	225	60203 3522 x 1	150	120	340
355	250	60203 3525 x 1	150	130	350
355	315	60203 3531 x 1	150	150	350
400	90	60203 4009 x 1	180	80	380
400	110	60203 4011 x 1	180	85	380
400	125	60203 4012 x 1	180	90	380
400	160	60203 4016 x 1	180	100	390
400	200	60203 4020 x 1	180	115	390
400	225	60203 4022 x 1	180	120	390
400	250	60203 4025 x 1	180	130	390
400	315	60203 4031 x 1	180	130	390
400	355	60203 4035 x 1	180	150	390
450	250	60203 4525 x 1	190	130	400
450	315	60203 4531 x 1	190	150	410
450	355	60203 4535 x 1	190	150	410
450	400	60203 4540 x 1	190	170	420
500	200	60203 5020 x 1	220	115	450

Material: HDPE 100

INSO 14427, ISO 4427

Length tolerance: $d_n \leq 315\text{mm}$: ± 10 mm and
 above 315 mm: ± 20 mm

Determine x of product code according to following table:

SDR	26	21	17	13.6	11	9	7.4
X	3	4	5	6	7	8	9

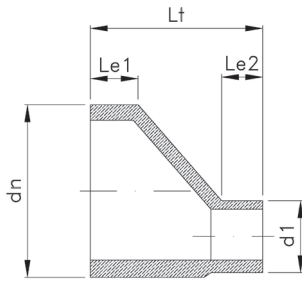

تبدیل غیر هم مرکز تزریقی پلی اتیلن
 Polyethylene Eccentric Reducer

محول البولى إيتيلين مختلف المركز
 Длинные эксцентрические переходники

Dimensions in millimeter

d_n	d_1	Code	L_{e1}	L_{e2}	L_t
500	225	60203 5022 x 1	220	120	450
500	250	60203 5025 x 1	220	130	450
500	315	60203 5031 x 1	220	140	450
500	355	60203 5035 x 1	220	150	450
500	400	60203 5040 x 1	220	160	450
500	450	60203 5045 x 1	220	190	470
560	200	60203 5620 x 1	230	115	460
560	225	60203 5622 x 1	230	120	460
560	250	60203 5625 x 1	230	130	460
560	315	60203 5631 x 1	230	135	470
560	355	60203 5635 x 1	230	140	470
560	400	60203 5640 x 1	230	140	470
560	450	60203 5645 x 1	230	160	470
560	500	60203 5650 x 1	230	200	490
630	200	60203 6320 x 1	250	115	460
630	225	60203 6322 x 1	250	120	460
630	250	60203 6325 x 1	250	125	460
630	315	60203 6331 x 1	250	130	470

Material: HDPE 100

INSO 14427, ISO 4427

Length tolerance: $d_n \leq 315\text{mm}$: ± 10 mm and
 above 315 mm: ± 20 mm

Determine x of product code according to following table:

SDR	26	21	17	13.6	11	9	7.4
X	3	4	5	6	7	8	9

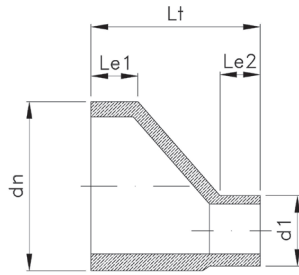

تبدیل غیر هم مرکز تزریقی پلی اتیلن
 Polyethylene Eccentric Reducer

محول البولی ایتیلین مختلف المركز
 Длинные эксцентрические переходники

Dimensions in millimeter

d_n	d_1	Code	L_{e1}	L_{e2}	L_t
630	355	60203 6335 x 1	250	140	470
630	400	60203 6340 x 1	250	140	470
630	450	60203 6345 x 1	250	160	480
630	500	60203 6350 x 1	250	190	500
630	560	60203 6356 x 1	250	200	500
710	200	60203 7120 x 1	250	110	450
710	225	60203 7122 x 1	250	115	450
710	250	60203 7125 x 1	250	120	450
710	315	60203 7131 x 1	250	120	450
710	355	60203 7135 x 1	250	130	460
710	400	60203 7140 x 1	250	140	470
710	450	60203 7145 x 1	250	160	480
710	500	60203 7150 x 1	250	180	490
710	560	60203 7156 x 1	250	200	500
710	630	60203 7163 x 1	250	220	510
800	200	60203 8020 x 1	250	110	460
800	225	60203 8022 x 1	250	115	460
800	250	60203 8025 x 1	250	120	460

Material: HDPE 100

INSO 14427, ISO 4427

Length tolerance: $d_n \leq 315\text{mm}$: ± 10 mm and
 above 315 mm: ± 20 mm

Determine x of product code according to following table:

SDR	26	21	17	13.6	11	9	7.4
X	3	4	5	6	7	8	9

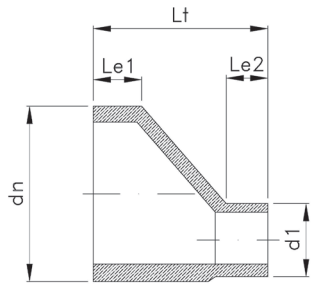

تبدیل غیر هم مرکز تزریقی پلی اتیلن
 Polyethylene Eccentric Reducer

محول البولی ایتیلین مختلف المرکز
 Длинные эксцентрисческие переходники

Dimensions in millimeter

d_n	d_1	Code	L_{e1}	L_{e2}	L_t
800	315	60203 8031 x 1	250	130	460
800	355	60203 8035 x 1	250	135	460
800	400	60203 8040 x 1	250	150	470
800	450	60203 8045 x 1	250	170	480
800	500	60203 8050 x 1	250	180	490
800	560	60203 8056 x 1	250	200	500
800	630	60203 8063 x 1	250	210	500
800	710	60203 8071 x 1	250	220	510

Material: HDPE 100

INSO 14427, ISO 4427

Length tolerance: $d_n \leq 315\text{mm}$: ± 10 mm and
 above 315 mm: ± 20 mm

Producing up to 1000mm is possible

Determine x of product code according to following table:

SDR	26	21	17	13.6	11	9	7.4
X	3	4	5	6	7	8	9

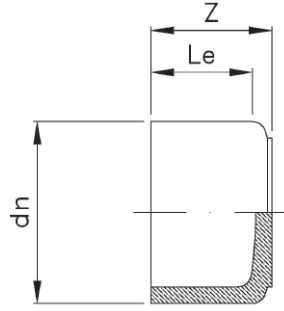

كپ تزریقى پلی اتیلن
 Polyethylene Cap

غطاء نهایی البولى ایتیلین
 Длты Заглушки

Dimensions in millimeter

d_n	Code	Z	L_e
75	60210 0700 x 1	85	70
90	60210 0900 x 1	90	79
110	60210 1100 x 1	110	82
125	60210 1200 x 1	115	87
140	60210 1400 x 1	120	92
160	60210 1600 x 1	130	98
180	60210 1800 x 1	130	105
200	60210 2000 x 1	140	112
225	60210 2200 x 1	145	120
250	60210 2500 x 1	150	129
280	60210 2800 x 1	160	139
315	60210 3100 x 1	170	150
355	60210 3500 x 1	110	75
400	60210 4000 x 1	120	75
450	60210 4500 x 1	130	75
500	60210 5000 x 1	140	75
560	60210 5600 x 1	165	80
630	60210 6300 x 1	150	80
710	60210 7100 x 1	200	100
800	60210 8000 x 1	200	100

Material: HDPE 100

INSO 14427, ISO 4427

Length tolerance: $d_n \leq 315\text{mm}$: ± 2 mm and
 above 315 mm: ± 5 mm

Determine x of product code according to following table:

SDR	26	21	17	13.6	11	9	7.4
X	3	4	5	6	7	8	9





اتصالات برنجی پلی اتیلن Polyethylene Branched Fittings

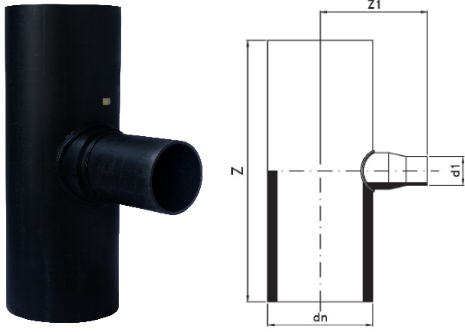

سه راهی ۹۰ درجه نامساوی پلی اتیلن
Polyethylene Saddle Fusion Reduced Tee
تی نقاص البولی ایثیلین ۹۰ درجه
Литые Тройники Переходные 90°

Dimensions in millimeter

d_n	d_1	Code	Z	Z_1
160	50	60209 1605 x 1	520	260
160	63	60209 1606 x 1		
160	75	60209 1607 x 1		
160	90	60209 1609 x 1		
160	110	60209 1611 x 1		
180	63	60209 1806 x 1	560	280
180	75	60209 1807 x 1		
180	90	60209 1809 x 1		
180	110	60209 1811 x 1		
180	125	60209 1812 x 1		
200	63	60209 2006 x 1	600	300
200	75	60209 2007 x 1		
200	90	60209 2009 x 1		
200	110	60209 2011 x 1		
200	125	60209 2012 x 1		
200	140	60209 2014 x 1		
225	75	60209 2207 x 1	650	325
225	90	60209 2209 x 1		

Material: HDPE 100
ASTM F 2620

Determine x of product code according to following table:

SDR	26	21	17	13.6	11	9	7.4
X	3	4	5	6	7	8	9

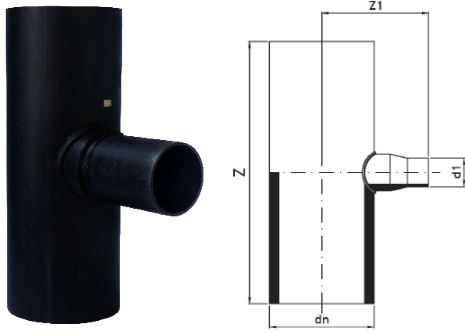

سه راهی ۹۰ درجه نامساوی پلی اتیلن
 Polyethylene Saddle Fusion Reduced Tee

تی نقاص البولی ایٹیلین ۹۰ درجه
 Литые Тройники Переходные 90°

Dimensions in millimeter

d_n	d_1	Code	Z	Z_1
225	110	60209 2211 x 1	650	325
225	125	60209 2212 x 1		
225	140	60209 2214 x 1		
225	160	60209 2216 x 1		
250	75	60209 2507 x 1	700	350
250	90	60209 2509 x 1		
250	110	60209 2511 x 1		
250	125	60209 2512 x 1		
250	140	60209 2514 x 1		
250	160	60209 2516 x 1		
250	180	60209 2518 x 1		
280	90	60209 2809 x 1	760	380
280	110	60209 2811 x 1		
280	125	60209 2812 x 1		
280	140	60209 2814 x 1		
280	160	60209 2816 x 1		
280	180	60209 2818 x 1		
280	200	60209 2820 x 1		

Material: HDPE 100
 ASTM F 2620

Determine x of product code according to following table:

SDR	26	21	17	13.6	11	9	7.4
X	3	4	5	6	7	8	9

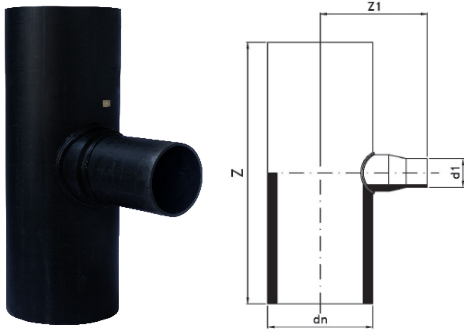

سه راهی ۹۰ درجه نامساوی پلی اتیلن
 Polyethylene Saddle Fusion Reduced Tee
 تی نقاص البولی ایثیلین ۹۰ درجه
 Литые Тройники Переходные 90°

Dimensions in millimeter

d_n	d_1	Code	Z	Z_1
315	110	60209 3111 x 1	830	415
315	125	60209 3112 x 1		
315	140	60209 3114 x 1		
315	160	60209 3116 x 1		
315	180	60209 3118 x 1		
315	200	60209 3120 x 1		
315	225	60209 3122 x 1		
355	110	60209 3511 x 1	920	460
355	125	60209 3512 x 1		
355	140	60209 3514 x 1		
355	160	60209 3516 x 1		
355	180	60209 3518 x 1		
355	200	60209 3520 x 1		
355	225	60209 3522 x 1		
355	250	60209 3525 x 1		
400	125	60209 4012 x 1		
400	140	60209 4014 x 1		
400	160	60209 4016 x 1		

Material: HDPE 100
 ASTM F 2620

Determine x of product code according to following table:

SDR	26	21	17	13.6	11	9	7.4
X	3	4	5	6	7	8	9

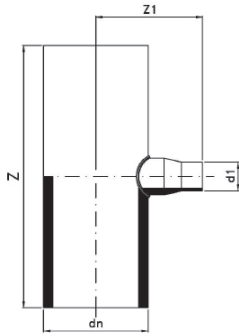

سه راهی ۹۰ درجه نامساوی پلی اتیلن
Polyethylene Saddle Fusion Reduced Tee

تی نقاص البولی إیثیلین ۹۰ درجه
Литые Тройники Переходные 90°

Dimensions in millimeter

d_n	d_1	Code	Z	Z_1
400	180	60209 4018 x 1	1000	500
400	200	60209 4020 x 1		
400	225	60209 4022 x 1		
400	250	60209 4025 x 1		
400	280	60209 4028 x 1	1100	550
450	140	60209 4514 x 1		
450	160	60209 4516 x 1		
450	180	60209 4518 x 1		
450	200	60209 4520 x 1		
450	225	60209 4522 x 1		
450	250	60209 4525 x 1		
450	280	60209 4528 x 1		
450	315	60209 4531 x 1	1200	600
500	160	60209 5016 x 1		
500	180	60209 5018 x 1		
500	200	60209 5020 x 1		
500	225	60209 5022 x 1		
500	250	60209 5025 x 1		

Material: HDPE 100
ASTM F 2620

Determine x of product code according to following table:

SDR	26	21	17	13.6	11	9	7.4
X	3	4	5	6	7	8	9

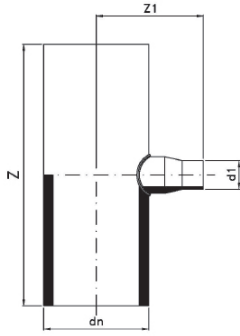

سه راهی ۹۰ درجه نامساوی پلی اتیلن
 Polyethylene Saddle Fusion Reduced Tee
 تی نقاص البولی ایثیلین ۹۰ درجه
 Литые Тройники Переходные 90°

Dimensions in millimeter

d_n	d_1	Code	Z	Z_1
500	280	60209 5028 x 1	1200	600
500	315	60209 5031 x 1		
500	355	60209 5035 x 1		
560	180	60209 5618 x 1		
560	200	60209 5620 x 1		
560	225	60209 5622 x 1		
560	250	60209 5625 x 1		
560	280	60209 5628 x 1	1320	660
560	315	60209 5631 x 1		
560	355	60209 5635 x 1		
560	400	60209 5640 x 1		
630	200	60209 6320 x 1		
630	225	60209 6322 x 1		
630	250	60209 6325 x 1		
630	280	60209 6328 x 1	1460	730
630	315	60209 6331 x 1		
630	355	60209 6335 x 1		
630	400	60209 6340 x 1		

Material: HDPE 100
 ASTM F 2620

Determine x of product code according to following table:

SDR	26	21	17	13.6	11	9	7.4
X	3	4	5	6	7	8	9



اتصالات دست ساز پلی اتیلن Polyethylene Fabricated Fittings



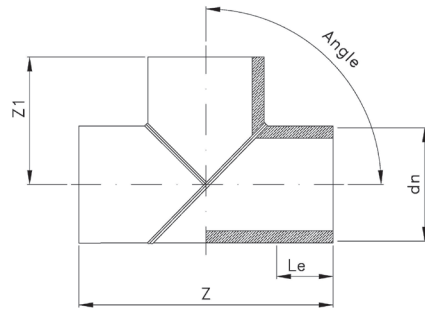

سه راهی ۹۰ درجه مساوی دست ساز پلی اتیلن
 Polyethylene Fabricated Equal Tee 90°

تی البولی إثیلین المتساویة الملحومة ۹۰ درجه
 Равные Сварные Тройники 90°

Dimensions in millimeter

d_n	Code	Z (min.)	Z_1 (min.)	L_e (min.)
63	60205 0606 x 1	410	205	150
75	60205 0707 x 1	410	205	150
90	60205 0909 x 1	410	205	150
110	60205 1111 x 1	410	205	150
125	60205 1212 x 1	430	215	150
140	60205 1414 x 1	440	220	150
160	60205 1616 x 1	460	230	150
180	60205 1818 x 1	480	240	150
200	60205 2020 x 1	500	250	150
225	60205 2222 x 1	530	265	150
250	60205 2525 x 1	750	375	250
280	60205 2828 x 1	780	390	250

Material: HDPE 100
 INSO 14427, ISO 4427
 $\alpha = \pm 2^\circ$

Determine x of product code according to following table:

SDR	26	21	17	13.6	11	9	7.4
X	3	4	5	6	7	8	9

Does not confirm to pressure rating. Pressure reduction of 0.5

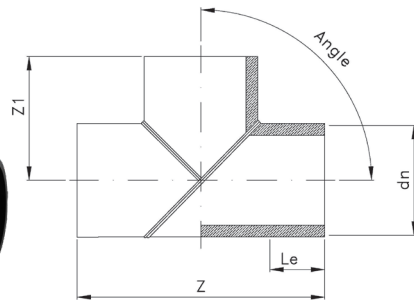

سه راهی ۹۰ درجه مساوی دست ساز پلی اتیلن
 Polyethylene Fabricated Equal Tee 90°

تی البولی إثیلین المتساویة الملحومة ۹۰ درجه
 Равные Сварные Тройники 90°

Dimensions in millimeter

d_n	Code	Z (min.)	Z ₁ (min.)	L _e (min.)
315	60205 3131 x 1	920	460	300
355	60205 3535 x 1	960	480	300
400	60205 4040 x 1	1000	500	300
450	60205 4545 x 1	1050	525	300
500	60205 5050 x 1	1200	600	350
560	60205 5656 x 1	1260	630	350
630	60205 6363 x 1	1330	665	350
710	60205 7171 x 1	1410	705	350
800	60205 8080 x 1	1500	750	350
900	60205 9090 x 1	1700	850	400
1000	60205 1010 x 1	1800	900	400
1200	60205 9292 x 1	2000	1000	400

Material: HDPE 100
 INSO 14427, ISO 4427
 $\alpha = \pm 2^\circ$

Determine x of product code according to following table:

SDR	26	21	17	13.6	11	9	7.4
X	3	4	5	6	7	8	9

Does not confirm to pressure rating. Pressure reduction of 0.5

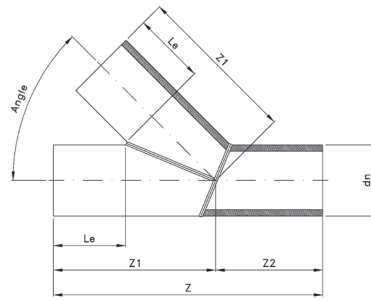

سه راهی ۴۵ درجه مساوی دست ساز پلی اتیلن
 Polyethylene Fabricated Equal Tee 45°

تی البولی إیثیلین الملحومه ۴۵ درجه
 Равные Сварные Тройники 45°

Dimensions in millimeter

d_n	Code	Z (min.)	Z_1 (min.)	Z_2 (min.)	L_e (min.)
63	60207 0606 x 1	500	325	175	150
75	60207 0707 x 1	500	325	175	150
90	60207 0909 x 1	500	325	175	150
110	60207 1111 x 1	500	325	175	150
125	60207 1212 x 1	545	355	190	150
140	60207 1414 x 1	581	375	206	150
160	60207 1616 x 1	642	412	230	150
180	60207 1818 x 1	700	450	250	150
200	60207 2020 x 1	759	487	272	150
225	60207 2222 x 1	830	530	300	150
250	60207 2525 x 1	905	580	325	250
280	60207 2828 x 1	995	630	365	250

Material: HDPE 100
 INSO 14427, ISO 4427
 $\alpha = \pm 2^\circ$

Determine x of product code according to following table:

SDR	26	21	17	13.6	11	9	7.4
X	3	4	5	6	7	8	9

Does not confirm to pressure rating. Pressure reduction of 0.5

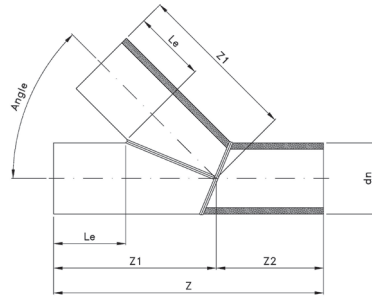

سه راهی ۴۵ درجه مساوی دست ساز پلی اتیلن
 Polyethylene Fabricated Equal Tee 45°

تی البولی إیثیلین الملحومة ۴۵ درجه
 Равные Сварные Тройники 45°

Dimensions in millimeter

d_n	Code	Z (min.)	Z ₁ (min.)	Z ₂ (min.)	L _e (min.)
315	60207 3131 x 1	1090	690	400	300
355	60207 3535 x 1	1155	730	425	300
400	60207 4040 x 1	1250	800	450	300
450	60207 4545 x 1	1325	850	475	300
500	60207 5050 x 1	1400	900	500	350
560	60207 5656 x 1	1480	950	530	350
630	60207 6363 x 1	1545	1000	545	350
710	60207 7171 x 1	1670	1090	580	350
800	60207 8080 x 1	1810	1180	630	350
900	60207 9090 x 1	1990	1320	670	400
1000	60207 1010 x 1	2070	1360	710	400
1200	60207 9292 x 1	2400	1540	860	400

Material: HDPE 100
 INSO 14427, ISO 4427
 $\alpha = \pm 2^\circ$

Determine x of product code according to following table:

SDR	26	21	17	13.6	11	9	7.4
X	3	4	5	6	7	8	9

Does not confirm to pressure rating. Pressure reduction of 0.5

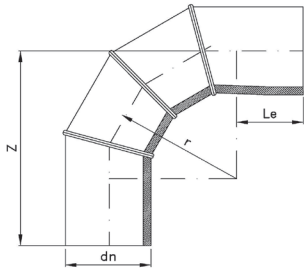

زانوی ۹۰ درجه دست ساز پلی اتیلن
 Polyethylene Fabricated Elbow 90°

رکبة البولى إيثيلين الملحومة ۹۰ درجه
 Сварные Отвод 90°

Dimensions in millimeter

d_n	Code	r	Z (min.)	L_e (min.)
63	60204 0690 x 1	142	315	150
75	60204 0790 x 1	113	315	150
90	60204 0990 x 1	135	315	150
110	60204 1190 x 1	165	315	150
125	60204 1290 x 1	188	338	150
140	60204 1490 x 1	210	360	150
160	60204 1690 x 1	240	390	150
180	60204 1890 x 1	270	420	150
200	60204 2090 x 1	300	450	150
225	60204 2290 x 1	338	488	150
250	60204 2590 x 1	375	625	250
280	60204 2890 x 1	420	670	250

Material: HDPE 100
 INSO 14427, ISO 4427
 $\alpha = \pm 2^\circ$
 $r = 1.5 d$

Does not confirm to pressure rating. Pressure reduction of 0.8

Determine x of product code according to following table:

SDR	26	21	17	13.6	11	9	7.4
X	3	4	5	6	7	8	9

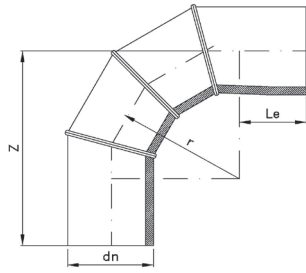

زانوی ۹۰ درجه دست ساز پلی اتیلن
 Polyethylene Fabricated Elbow 90°
 ركبۃ البولي إيثيلين الملحومة ۹۰ درجة
 Сварные Отвод 90°

Dimensions in millimeter

d_n	Code	r	Z (min.)	L_e (min.)
315	60204 3190 x 1	473	773	300
355	60204 3590 x 1	533	833	300
400	60204 4090 x 1	600	900	300
450	60204 4590 x 1	675	975	300
500	60204 5090 x 1	750	1100	350
560	60204 5690 x 1	840	1190	350
630	60204 6390 x 1	945	1295	350
710	60204 7190 x 1	1065	1415	350
800	60204 8090 x 1	1200	1550	350
900	60204 9090 x 1	1350	1750	400
1000	60204 1090 x 1	1500	1900	400
1200	60204 9290 x 1	1800	1900	400

Material: HDPE 100
 INSO 14427, ISO 4427
 $\alpha = \pm 2^\circ$
 $r = 1.5 d$

Determine x of product code according to following table:

SDR	26	21	17	13.6	11	9	7.4
X	3	4	5	6	7	8	9

Does not confirm to pressure rating. Pressure reduction of 0.8

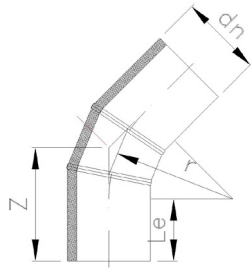

زانوی ۴۵، ۶۰ درجه دست ساز پلی اتیلن
 Polyethylene Fabricated Elbow 45°,60°

رکبة البولى إيثيلين الملحومة ۴۵ و ۶۰ درجه
 Сварные Отвод 45°,60°

Dimensions in millimeter

dn	Code		r	Z (min.)		Le(min.)
	$\alpha = 45^\circ$	$\alpha = 60^\circ$		$\alpha = 45^\circ$	$\alpha = 60^\circ$	
63	60204 0645 x 1	60204 0660 x 1	142	218	245	150
75	60204 0745 x 1	60204 0760 x 1	113	218	245	150
90	60204 0945 x 1	60204 0960 x 1	135	218	245	150
110	60204 1145 x 1	60204 1160 x 1	165	218	245	150
125	60204 1245 x 1	60204 1260 x 1	188	228	258	150
140	60204 1445 x 1	60204 1460 x 1	210	237	271	150
160	60204 1645 x 1	60204 1660 x 1	240	249	288	150
180	60204 1845 x 1	60204 1860 x 1	270	262	305	150
200	60204 2045 x 1	60204 2060 x 1	300	274	323	150
225	60204 2245 x 1	60204 2260 x 1	338	290	345	150
250	60204 2545 x 1	60204 2560 x 1	375	412	466	250
280	60204 2845 x 1	60204 2860 x 1	420	424	492	250

Material: HDPE 100
 INSO 14427, ISO 4427
 $\alpha = \pm 2^\circ$
 $r = 1.5 d$

Determine x of product code according to following table:

SDR	26	21	17	13.6	11	9	7.4
X	3	4	5	6	7	8	9

Does not confirm to pressure rating. Pressure reduction of 0.8

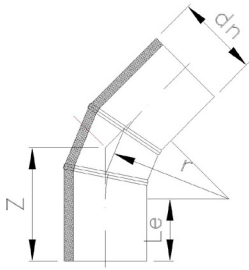

زانوی ۴۵، ۶۰ درجه دست ساز پلی اتیلن
 Polyethylene Fabricated Elbow 45°, 60°

ركبة البولي إيثيلين الملحومة ۴۵ و ۶۰ درجة
 Сварные Отвод 45°, 60°

Dimensions in millimeter

dn	Code		r	Z (min.)		Le(min.)
	$\alpha = 45^\circ$	$\alpha = 60^\circ$		$\alpha = 45^\circ$	$\alpha = 60^\circ$	
315	60204 3145 x 1	60204 3160 x 1	473	498	576	300
355	60204 3545 x 1	60204 3560 x 1	533	520	608	300
400	60204 4045 x 1	60204 4060 x 1	600	548	646	300
450	60204 4545 x 1	60204 4560 x 1	675	580	689	300
500	60204 5045 x 1	60204 5060 x 1	750	665	783	350
560	60204 5645 x 1	60204 5660 x 1	840	698	835	350
630	60204 6345 x 1	60204 6360 x 1	945	741	896	350
710	60204 7145 x 1	60204 7160 x 1	1065	792	965	350
800	60204 8045 x 1	60204 8060 x 1	1200	847	1043	350
900	60204 9045 x 1	60204 9060 x 1	1350	960	1179	400
1000	60204 1045 x 1	60204 1060 x 1	1500	1022	1266	400
1200	60204 9245 x 1	60204 9260 x 1	1800	1022	1266	400

Material: HDPE 100
 INSO 14427, ISO 4427
 $\alpha = \pm 2^\circ$
 $r = 1.5 d$

Determine x of product code according to following table:

SDR	26	21	17	13.6	11	9	7.4
X	3	4	5	6	7	8	9

Does not confirm to pressure rating. Pressure reduction of 0.8

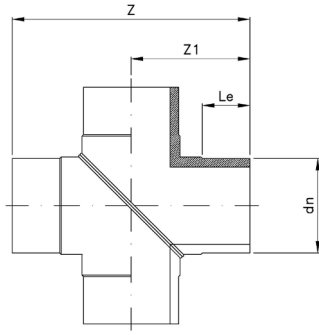

چهارراه ۹۰ درجه دست ساز پلی اتیلن
 Polyethylene Fabricated Cross 90°

صليب مصنوع من البولى إيثيلين ۹۰ درجه
 Сварные Крест 90°

Dimensions in millimeter

d_n	Code	Z	Z ₁	L _e
90	60213 0909 x 1	270	135	75
110	60213 1111 x 1	320	160	85
125	60213 1212 x 1	350	175	90
160	60213 1616 x 1	400	200	100
200	60213 2020 x 1	480	240	110
250	60213 2525 x 1	550	275	120
315	60213 3131 x 1	590	300	120

Material: HDPE 100
 INSO 14427, ISO 4427
 $\alpha = \pm 2^\circ$

Does not confirm to pressure rating. Pressure reduction of 0.8

Determine x of product code according to following table:

SDR	26	21	17	13.6	11	9	7.4
X	3	4	5	6	7	8	9



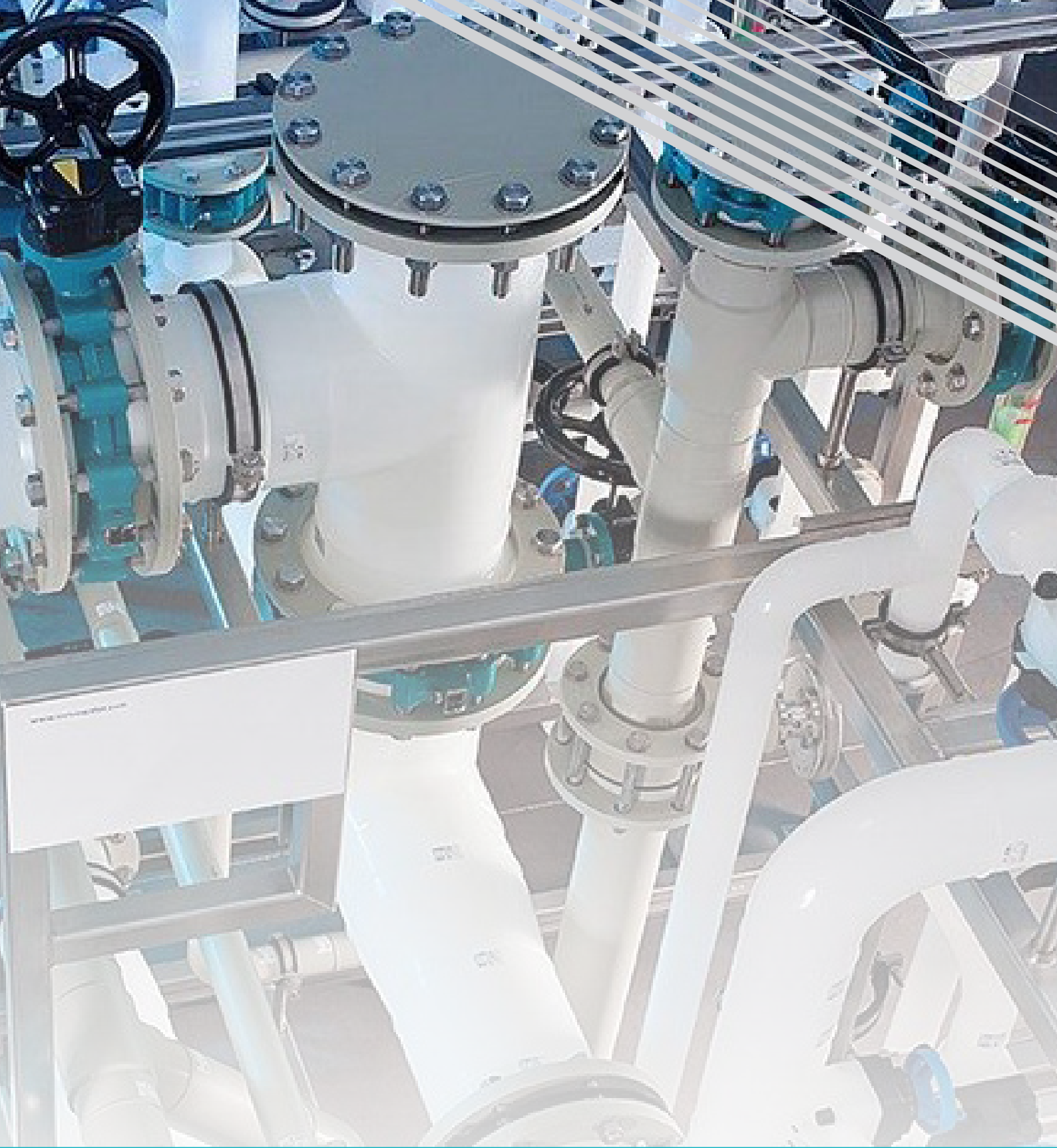

رینگ Backing Ring

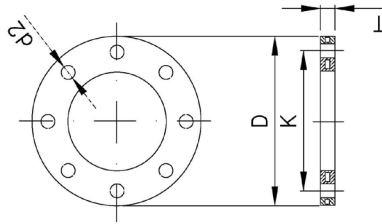

رینگ فولادی با پوشش پلیمری تقویت شده
 Steel Ring / PP Reinforced (Bolt circle PN10)

حلقه فولادیه / مقوی بالبولی پروبیلین
 Металлические Кольца / PP
 армированный (PN10)

Dimensions in millimeter

DN	d _n	Code	D	K	d ₂	Bolting		T
						Number	Size	
50	63	60226 060604	165	125	18	4	M 16	20
65	75	60226 070604	185	145	18	4	M 16	20
80	90	60226 090608	200	160	18	8	M 16	20
100	110	60226 110808	220	180	18	8	M 16	22
100	125	60226 120808	220	180	18	8	M 16	22
125	125	60226 120808	250	210	18	8	M 16	22
125	140	60226 140808	250	210	18	8	M 16	22
150	160	60226 160808	285	240	22	8	M 20	24
150	180	60226 180808	285	240	22	8	M 20	24
200	200	60226 201008	340	295	22	8	M 20	24
200	225	60226 221008	340	295	22	8	M 20	24
250	250	60226 251212	398	350	22	12	M 20	26
250	280	60226 281212	398	350	22	12	M 20	26
300	315	60226 311212	455	400	22	12	M 20	26

Material: PP glass-fiber reinforced with steel ring
 Drilling: EN 1092, DIN 2501
 Bolt circle PN10

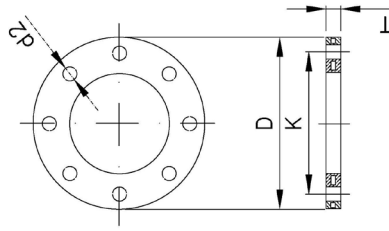

رینگ فولادی با پوشش پلیمری تقویت شده
 Steel Ring / PP Reinforced (Bolt circle PN16)

حلقه فولادیه / مقوی بالبولی پروبیلین
 Metalliche Kольца /
 PP армированный (PN16)

Dimensions in millimeter

DN	d _n	Code	D	K	d ₂	Bolting		T
						Number	Size	
50	63	60226 060604	165	125	18	4	M 16	20
65	75	60226 070604	185	145	18	4	M 16	20
80	90	60226 090808	200	160	18	8	M 16	20
100	110	60226 110808	220	180	18	8	M 16	22
100	125	60226 120808	220	180	18	8	M 16	22
125	125	60226 120808	250	210	18	8	M 16	22
125	140	60226 140808	250	210	18	8	M 16	22
150	160	60226 161008	285	240	22	8	M 20	24
150	180	60226 181008	285	240	22	8	M 20	24
200	200	60226 201212	340	295	22	12	M 20	26
200	225	60226 221212	340	295	22	12	M 20	26
250	250	60226 251212	405	355	26	12	M 24	29
250	280	60226 281212	405	355	26	12	M 24	29
300	315	60226 311512	470	410	26	12	M 24	32

Material: PP glass-fiber reinforced with steel ring
 Drilling: EN 1092, DIN 2501
 Bolt circle PN16

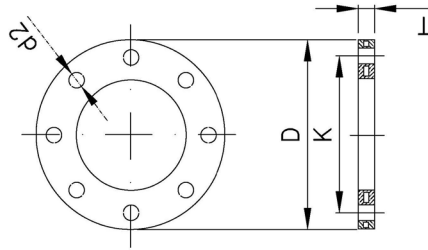

رینگ فولادی با پوشش پلیمری تقویت شده
Steel Ring / PP Reinforced (Bolt circle class 150)

حلقة فولاذية / مقوى بالبولى بروبيلين
Металлические Кольца / PP
армированный (#150)

Dimensions in millimeter

DN	dn	Code	D	K	d ₂	Bolting		T
						Number	Size	
2	63	60226 060604	160	120.7	19	4	M 16	20
2 1/2	75	60226 070604	180	139.7	19	4	M 16	22
3	90	60226 090804	195	152.4	19	4	M 16	22
4	110	60226 110808	230	190.5	19	8	M 16	22
5	125	60226 120808	230	190.5	19	8	M 16	22
5 1/2	140	60226 120808	260	215.9	22	8	M 19	22
6	160	60226 140808	285	240.7	22	8	M 19	24
7	180	60226 161008	285	240.7	22	8	M 19	24
8	200	60226 181008	345	298.5	22	8	M 19	28
9	225	60226 201208	345	298.5	22	8	M 19	28
10	250	60226 221212	410	362	25	12	M 22	29
11	280	60226 251212	410	362	25	12	M 22	29
12	315	60226 281212	490	431.8	25	12	M 22	32

Material: PP glass-fiber reinforced with steel ring
Drilling: ASME B16.5
Bolt circle class 150

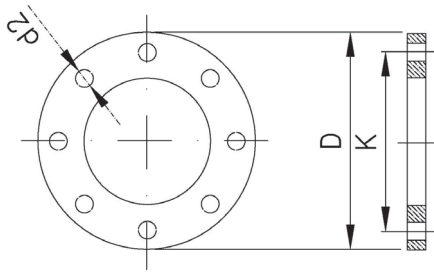

رینگ فولادی
 Steel Back Ring (Bolt circle PN10)

حلقة دعم الصلب
 Metalliche Kольца

Dimensions in millimeter

DN (inch)	d_n	Code	D	K	d_2	Bolting	
						Number	Size
15	20	50211 02 x 0 y	95	65	14	4	M 12
20	25	50211 025 x 0 y	105	75	14	4	M 12
25	32	50211 03 x 0 y	115	85	14	4	M 12
32	40	50211 04 x 0 y	140	100	18	4	M 16
40	50	50211 05 x 0 y	150	110	18	4	M 16
50	63	50211 06 x 0 y	165	125	18	4	M 16
65	75	50211 07 x 0 y	185	145	18	4	M 16
80	90	50211 09 x 0 y	200	160	18	8	M 16
100	110	50211 11 x 0 y	220	180	18	8	M 16
100	125	50211 12 x 0 y	220	180	18	8	M 16
125	140	50211 14 x 0 y	250	210	18	8	M 16
150	160	50211 16 x 0 y	285	240	22	8	M 20
150	180	50211 18 x 0 y	285	240	22	8	M 20
200	200	50211 20 x 0 y	340	295	22	8	M 20
200	225	50211 22 x 0 y	340	295	22	8	M 20

Drilling: EN 1092, DIN 2501
 Bolt circle PN10
 x: Steel Backing Ring thickness according to customer order

Determine y of product code according to following table:

	Cold Galvanized	Hot Galvanized
y	1	2

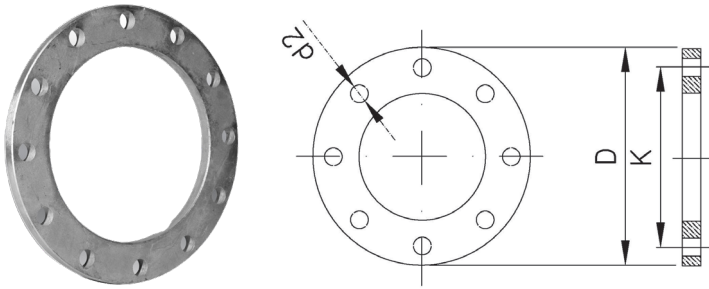

رینگ فولادی
 Steel Back Ring (Bolt circle PN10)

حلقة دعم الصلب
 Metalliche Kольца

Dimensions in millimeter

DN (inch)	d_n	Code	D	K	d_2	Bolting	
						Number	Size
250	250	50211 25 x 0 y	395	350	22	12	M 20
250	280	50211 28 x 0 y	395	350	22	12	M 20
300	315	50211 31 x 0 y	445	400	22	12	M 20
350	355	50211 35 x 0 y	505	460	22	16	M 20
400	400	50211 40 x 0 y	565	515	26	16	M 24
450	450(450)	50211 45 x 0 y	615	565	26	20	M 24
500	450(500)	50211 45 x 0 yA	670	620	26	20	M 24
500	500	50211 50 x 0 y	670	620	26	20	M 24
600	560	50211 56 x 0 y	780	725	30	20	M 27
600	630	50211 63 x 0 y	780	725	30	20	M 27
700	710	50211 71 x 0 y	895	840	30	24	M 27
800	800	50211 80 x 0 y	1015	950	33	24	M 30
900	900	50211 90 x 0 y	1115	1050	33	28	M 30
1000	1000	50211 10 x 0 y	1230	1160	36	28	M 33
1200	1200	50211 92 x 0 y	1455	1380	39	32	M 36

Drilling: EN 1092, DIN 2501
 Bolt circle PN10
 x: Steel Backing Ring thickness according to customer order

Determine y of product code according to following table:

	Cold Galvanized	Hot Galvanized
y	1	2

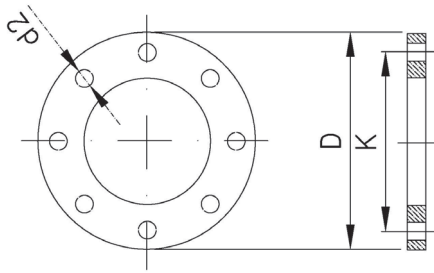

رینگ فولادی
 Steel Back Ring (Bolt circle PN16)

حلقة دعم الصلب
 Metalliche Kольца

Dimensions in millimeter

DN (inch)	d _n	Code	D	K	d ₂	Bolting	
						Number	Size
15	20	50211 02 x 2 y	95	65	14	4	M 12
20	25	50211 025 x 2 y	102	75	14	4	M 12
25	32	50211 03 x 2 y	115	85	14	4	M 12
32	40	50211 04 x 2 y	140	100	18	4	M 16
40	50	50211 05 x 2 y	150	110	18	4	M 16
50	63	50211 06 x 2 y	165	125	18	4	M 16
65	75	50211 07 x 2 y	185	145	18	4	M 16
80	90	50211 09 x 2 y	200	160	18	8	M 16
100	110	50211 11 x 2 y	220	180	18	8	M 16
100	125	50211 12 x 2 y	220	180	18	8	M 16
125	140	50211 14 x 2 y	250	210	18	8	M 16
150	160	50211 16 x 2 y	285	240	22	8	M 20
150	180	50211 18 x 2 y	285	240	22	8	M 20
200	200	50211 20 x 2 y	340	295	22	12	M 20
200	225	50211 22 x 2 y	340	295	22	12	M 20

Drilling: EN 1092, DIN 2501
 Bolt circle PN16
 x: Steel Backing Ring thickness according to customer order

Determine y of product code according to following table:

	Cold Galvanized	Hot Galvanized
y	1	2

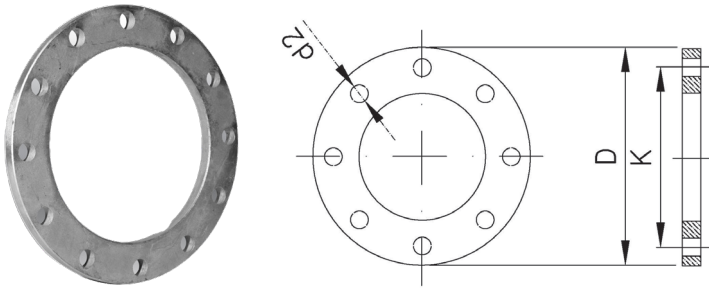

رینگ فولادی
 Steel Back Ring (Bolt circle PN16)

حلقة دعم الصلب
 Metalliche Kольца

Dimensions in millimeter

DN (inch)	d_n	Code	D	K	d_2	Bolting	
						Number	Size
250	250	50211 25 x 2 y	405	355	26	12	M 24
250	280	50211 28 x 2 y	405	355	26	12	M 24
300	315	50211 31 x 2 y	460	410	26	12	M 24
350	355	50211 35 x 2 y	520	470	26	16	M 24
400	400	50211 40 x 2 y	580	525	30	16	M 27
450	450(450)	50211 45 x 2 y	640	585	30	20	M 27
500	450(500)	50211 45 x 2 yA	715	650	33	20	M 30
500	500	50211 50 x 2 y	715	650	33	20	M 30
600	560	50211 56 x 2 y	840	770	36	20	M 33
600	630	50211 63 x 2 y	840	770	36	20	M 33
700	710	50211 71 x 2 y	910	840	36	24	M 33
800	800	50211 80 x 2 y	1025	950	39	24	M 36
900	900	50211 90 x 2 y	1125	1050	39	28	M 36
1000	1000	50211 10 x 2 y	1255	1170	42	28	M 39
1200	1200	50211 92 x 2 y	1485	1390	48	32	M 45

Drilling: EN 1092, DIN 2501
 Bolt circle PN16
 x: Steel Backing Ring thickness according to customer order

Determine y of product code according to following table:

	Cold Galvanized	Hot Galvanized
y	1	2

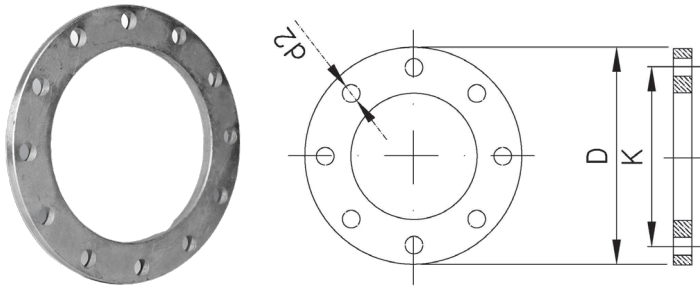

رینگ فولادی
 Steel Back Ring (Bolt circle class 150)

حلقة دعم الصلب
 Металлические Кольца

Dimensions in millimeter

DN (inch)	d _n	Code	D	K	d ₂	Bolting	
						Number	Size
1/2	20	50211 02 x 1 y	90	60.3	16	4	M 12
3/4	25	50211 025 x 1 y	100	69.9	16	4	M 12
1	32	50211 03 x 1 y	110	79.4	16	4	M 12
1 1/4	40	50211 04 x 1 y	115	88.9	16	4	M 12
1 1/2	50	50211 05 x 1 y	125	98.4	16	4	M 12
2	63	50211 06 x 1 y	150	120.7	19	4	M 16
2 1/2	75	50211 07 x 1 y	180	139.7	19	4	M 16
3	90	50211 09 x 1 y	190	152.4	19	4	M 16
4	110	50211 11 x 1 y	230	190.5	19	8	M 16
5	125	50211 12 x 1 y	255	215.9	22	8	M 19
5 1/2	140	50211 14 x 1 y	255	215.9	22	8	M 19
6	160	50211 16 x 1 y	280	241.3	22	8	M 19
7	180	50211 18 x 1 y	280	241.3	22	8	M 19
8	200	50211 20 x 1 y	345	298.5	22	8	M 19
9	225	50211 22 x 1 y	345	298.5	22	8	M 19

Drilling: ASME B 16.5
 Bolt circle Class 150
 x: Steel Backing Ring thickness according to customer order

Determine y of product code according to following table:

	Cold Galvanized	Hot Galvanized
y	1	2

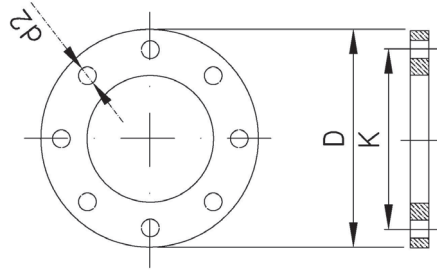

رینگ فولادی
 Steel Back Ring (Bolt circle class 150)

حلقة دعم الصلب
 Металлические Кольца

Dimensions in millimeter

DN (inch)	d_n	Code	D	K	d_2	Bolthing	
						Number	Size
10	250	50211 25 x 1 y	405	362	25	12	M 22
11	280	50211 28 x 1 y	405	362	25	12	M 22
12	315	50211 31 x 1 y	485	431.8	25	12	M 22
14	355	50211 35 x 1 y	535	476.3	29	12	M 25
16	400	50211 40 x 1 y	595	539.8	29	16	M 25
18	450(450)	50211 45 x 1 y	635	577.9	31	16	M 29
18	450(500)	50211 45 x 1 yA	635	577.9	31	16	M 29
20	500	50211 50 x 1 y	700	635	31	20	M 29
20	560	50211 56 x 1 y	700	635	31	20	M 29
24	630	50211 63 x 1 y	815	749.3	35	20	M 31

Drilling: ASME B 16.5
 Bolt circle Class 150
 x: Steel Backing Ring thickness according to customer order

Determine y of product code according to following table:

	Cold Galvanized	Hot Galvanized
y	1	2

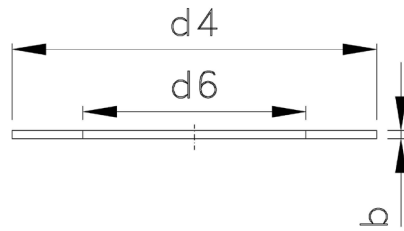

واشر تخت لاستیکی
 Flat Face Rubber Gasket

حشیه مطابیه ذات وجه مسطح
 Прокладк

Dimensions in millimeter

d_n	Code		d_4	d_6		b
	SDR17	SDR11		SDR17	SDR11	
20	50212 0200 02	50212 0200 22	45	-	16	3
25	50212 02500 02	50212 02500 22	58	21	20	3
32	50212 0300 02	50212 0300 22	68	28	26	3
40	50212 0400 02	50212 0400 22	78	35	33	3
50	50212 0500 02	50212 0500 22	88	44	41	3
63	50212 0600 02	50212 0600 22	102	56	51	3
75	50212 0700 02	50212 0700 22	122	66	61	3
90	50212 0900 02	50212 0900 22	138	80	74	3
110	50212 1100 02	50212 1100 22	158	97	90	3
125	50212 1200 02	50212 1200 22	158	111	102	3
140	50212 1400 02	50212 1400 22	188	124	114	3
160	50212 1600 02	50212 1600 22	212	142	131	3
180	50212 1800 02	50212 1800 22	212	160	147	3
200	50212 2000 02	50212 2000 22	268	177	164	3
225	50212 2200 02	50212 2200 22	268	199	184	3

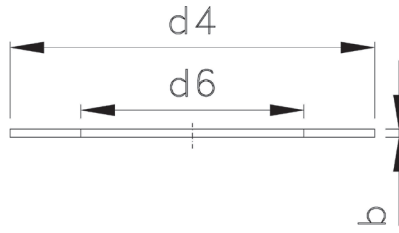
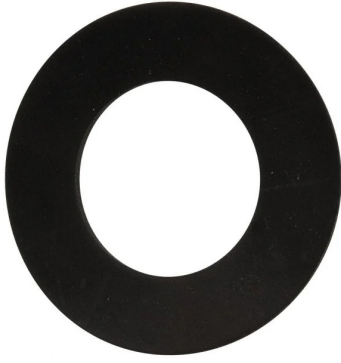

واشر تخت لاستيكي
 Flat Face Rubber Gasket

حشية مطاطية ذات وجه مسطح
 Прокладк

Dimensions in millimeter

d_n	Code		d_4	d_6		b	
	SDR17	SDR11		SDR17	SDR11	SDR17	SDR11
250	50212 2500 02	50212 2500 22	320	222	204	3	5
280	50212 2800 02	50212 2800 22	320	248	229	3	5
315	50212 3100 02	50212 3100 22	370	279	258	3	5
355	50212 3500 02	50212 3500 22	430	315	290	3	5
400	50212 4000 02	50212 4000 22	482	355	327	3	5
450(450)	50212 4500 02	50212 4500 22	538	399	368	5	5
450(500)	50212 4500 02A	50212 4500 22A	585	399	368	5	5
500	50212 5000 02	50212 5000 22	585	443	409	5	5
560	50212 5600 02	50212 5600 22	685	497	456	5	5
630	50212 6300 02	50212 6300 22	685	559	513	5	5
710	50212 7100 02	50212 7100 22	800	630	-	5	5
800	50212 8000 02	50212 8000 22	905	709	-	5	5
900	50212 9000 02	50212 9000 22	1005	798	-	5	5
1000	50212 1000 02	50212 1000 22	1110	885	-	5	5
1200	50212 9200 02	50212 9200 22	1330	-	-	5	5



شیر پلی اتیلن Polyethylene Valve



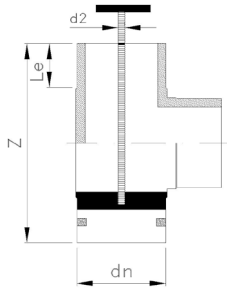

شیر آبریز انتهای خط
 On-off valve
 صمام ON-OFF
 Двухпозиционный клапан

Dimensions in millimeter

d_n	Code	Z	L_e	d_2
160	60224 1600 31B	320	75	22

Material: HDPE 100
 PN 4bar



www.abramettesal.com



ABRAM
ETTESAL



تهران، سعادت آباد، سرو غربی، خیابان شکوفه، کوچه جوی پا،
ساختمان صنوبر، پلاک ۲۲، واحد ۲۲

Tel: +98 21 22378763 - 4
info@abramettesal.com

Fax: +98 21 22381274
www.abramettesal.com

